

MOULD COOLING COUPLINGS  
KÜHLUNGSELEMENTE FÜR WERKZEUGE

# SERIE 6-9-16



INTERNATIONAL SERIE

---

MOULD COOLING COUPLINGS  
KÜHLUNGSELEMENTE FÜR WERKZEUGE

# SERIE 6-9-16



### Materials

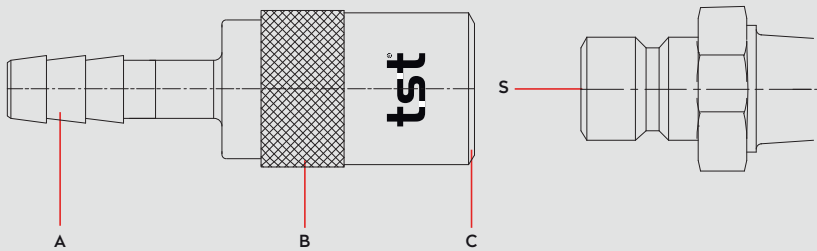

### Material Code

- A = Brass
- B = Brass
- C = Brass
- S = Brass



0 - 15 bar



-26°C to + 200°C (FPM)

### Shut Off Type



### COUPLING

- TST 6 → 006 GC 00V
- TST 9 → 009 GC 00V
- TST 16 → 016 GC 00V

### FLOW

- TST 6 → 35 lt/min → ↔
- TST 9 → 60 lt/min → ↔
- TST 16 → 85 lt/min → ↔
- TST 6 → 15 lt/min → ↔
- TST 9 → 30 lt/min → ↔

### DN

- TST 6 → 6 mm
- TST 9 → 9 mm
- TST 16 → 16 mm

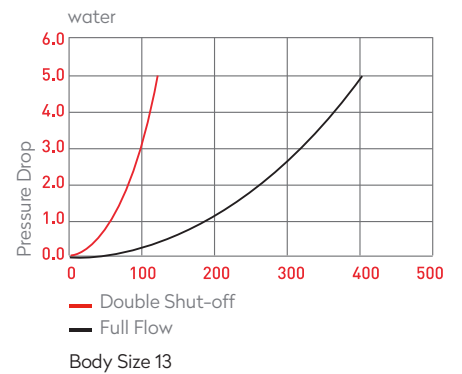
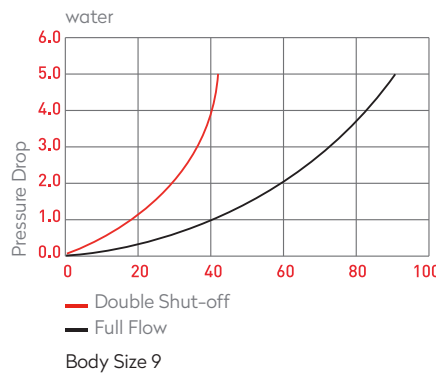
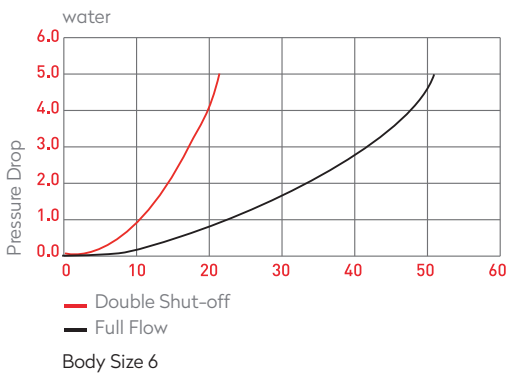

### Options

- Id. Ring
- E1
- E2
- NBR
- NICKEL
- JR
- NPT

### Applications

Cooling System

International Serie

### Compatible with

DME  
 JIFFY TITE  
 RECTUS 86-87-88  
 LÜDECKE ESDMF 6, ESDF 9



MOULD COOLING COUPLINGS  
KÜHLUNGSELEMENTE FÜR WERKZEUGE

# SERIE 6-9-16

## QUICK COUPLINGS SCHNELLKUPPLUNGEN

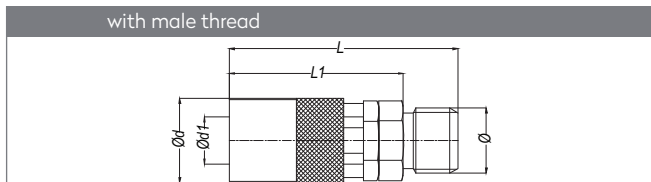

↻ / With Valve	← / Without Valve	Serie	Ø	Ød	Ød1	L	L1
HVK 6 EG 10	HK 6 EG 10	200	BSP 1/8"	17	9.5	44	35
HVK 6 EG 13	HK 6 EG 13	200	BSP 1/4"	17	9.5	46	35
HVK 6 EGM 14	HK 6 EGM 14	200	M14x1.5	17	9.5	46	35
HVK 6 EG 17	HK 6 EG 17	200	BSP 3/8"	17	9.5	46	35
HVK 9 EG 13	HK 9 EG 13	300	BSP 1/4"	23.3	13.5	56	45
HVK 9 EGM 16	HK 9 EGM 16	300	M16x1.5	23.3	13.5	56	45
HVK 9 EG 17	HK 9 EG 17	300	BSP 3/8"	23.3	13.5	56	45
HVK 9 EGM 18	HK 9 EGM 18	300	M18 x1.5	23.3	13.5	57	45
HVK 9 EG 21	HK 9 EG 21	300	BSP 1/2"	23.3	13.5	58	45
HVK 16 EG 21	HK 16 EG 21	500	BSP 1/2"	32	20.1	78	66
HVK 16 EG 26	HK 16 EG 26	500	BSP 3/4"	32	20.1	82	66

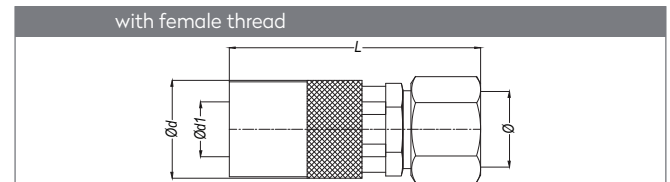

↻ / With Valve	← / Without Valve	Serie	Ø	Ød	Ød1	L
HVK 6 DG 10	HK 6 DG 10	200	BSP 1/8"	17	9.5	40
HVK 6 DG 13	HK 6 DG 13	200	BSP 1/4"	17	9.5	43.6
HVK 6 DGM 14	HK 6 DGM 14	200	M14x1.5	17	9.5	43.6
HVK 6 DG 17	HK 6 DG 17	200	BSP 3/8"	17	9.5	43.6
HVK 9 DG 13	HK 9 DG 13	300	BSP 1/4"	23.3	13.5	52
HVK 9 DG 17	HK 9 DG 17	300	BSP 3/8"	23.3	13.5	52
HVK 9 DG 21	HK 9 DG 21	300	BSP 1/2"	23.3	13.5	57
HVK 16 DG 21	HK 16 DG 21	500	BSP 1/2"	32	20.1	75

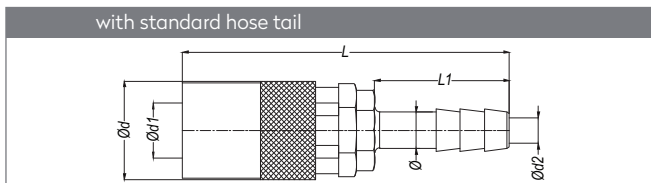

↻ / With Valve	Serie	Ø	Ød	Ød1	Ød2	L	L1
HVK 6-06	200	6.3-1/4"	17	9.5	4	56.5	23.3
HVK 6-08	200	8-5/16"	17	9.5	6	56.5	23.3
HVK 6-09	200	9-5/14"	17	9.5	7	56.5	23.3
HVK 6-10	200	10-3/8"	17	9.5	8	56.5	23.3
HVK 9-10	300	10-3/8"	23.3	13.5	8	61	25.3
HVK 9-11	300	11-7/16"	23.3	13.5	9	61	25.3
HVK 9-13	300	13-1/2"	23.3	13.5	10	61	25.3

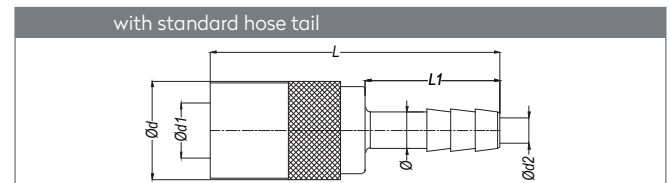

← / Without Valve	Serie	Ø	Ød	Ød1	Ød2	L	L1
HK 6-06	200	6.3-1/4"	17	9.5	4	56.5	23.3
HK 6-08	200	8-5/16"	17	9.5	6	56.5	23.3
HK 6-09	200	9-5/14"	17	9.5	7	56.5	23.3
HK 6-10	200	10-3/8"	17	9.5	8	56.5	23.3
HK 9-10	300	10-3/8"	23.3	13.5	8	61	25.3
HK 9-11	300	11-7/16"	23.3	13.5	9	61	25.3
HK 9-13	300	13-1/2"	23.3	13.5	10	61	25.3
HK 16-13	500	13-1/2"	32	20.1	10	93	27
HK 16-16	500	16-5/8"	32	20.1	13	93	27
HK 16-19	500	19-3/4"	32	20.1	16	93	27
HVK 16-13	500	13-1/2"	32	20.1	10	93	27
HVK 16-16	500	16-5/8"	32	20.1	13	93	27
HVK 16-19	500	19-3/4"	32	20.1	16	93	27

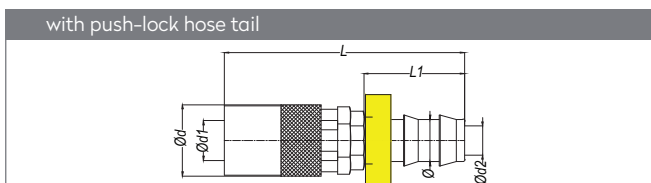

↻ / With Valve	Serie	Ø	Ød	Ød1	Ød2	L	L1
HVK 6 FG 06	200	6.7-1/4"	17	9.5	4.5	50	24
HVK 6 FG 10	200	10-3/8"	17	9.5	7.5	50	24
HVK 9 FG 10	300	10-3/8"	23.3	13.5	7.5	60	24
HVK 9 FG 13	300	13-1/2"	23.3	13.5	9	64	28

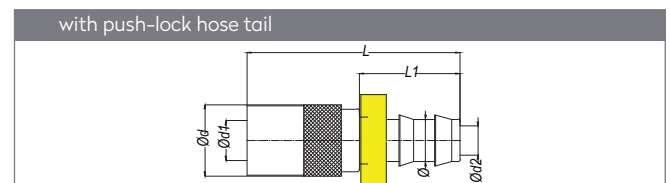

← / Without Valve	Serie	Ø	Ød	Ød1	Ød2	L	L1
HK 6 FG 06	200	6.7-1/4"	17	9.5	4.5	50	24
HK 6 FG 10	200	10-3/8"	17	9.5	7.5	50	24
HK 9 FG 10	300	10-3/8"	23.3	13.5	7.5	60	24
HK 9 FG 13	300	13-1/2"	23.3	13.5	9	64	28
HK 16 FG 13	500	13-1/2"	32	20.1	9	93	28
HK 16 FG 16	500	16-5/8"	32	20.1	13	103	38
HK 16 FG 19	500	19-3/4"	32	20.1	15	103	38
HVK 16 FG 13	500	13-1/2"	32	20.1	9	93	28
HVK 16 FG 16	500	16-5/8"	32	20.1	13	103	38
HVK 16 FG 19	500	19-3/4"	32	20.1	15	103	38

## MOULD COOLING COUPLINGS

## KÜHLUNGSELEMENTE FÜR WERKZEUGE

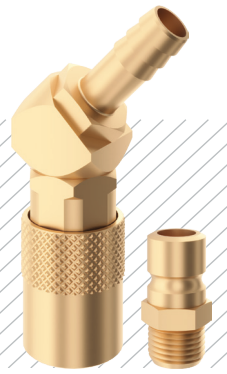

# SERIE 6-9-16



### QUICK COUPLINGS SCHNELLKUPPLUNGEN

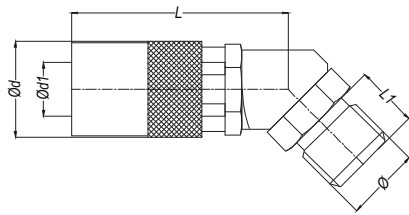

with male thread 45°



 / With Valve	 / Without Valve	Serie	Ø	Ød	Ød1	L	L1
HVK 6 EG 10-45°	HK 6 EG 10-45°	200	BSP 1/8"	17	9.5	38.2	9
HVK 6 EG 13-45°	HK 6 EG 13-45°	200	BSP 1/4"	17	9.5	38.2	11
HVK 9 EG 13-45°	HK 9 EG 13-45°	300	BSP 1/4"	23.3	13.5	49.8	11
HVK 9 EGM 16-45°	HK 9 EGM 16-45°	300	M16x1.5	23.3	13.5	49.8	11
HVK 9 EG 17-45°	HK 9 EG 17-45°	300	BSP 3/8"	23.3	13.5	49.8	11
HVK 9 EG 21-45°	HK 9 EG 21-45°	300	BSP 1/2"	23.3	13.5	49.8	11
HVK 16 EG 21-45°	HK 16 EG 21-45°	500	BSP 1/2"	32	20.1	73	12

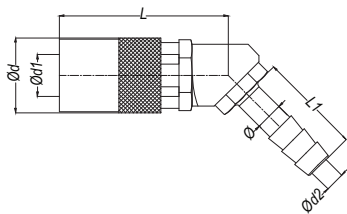

with standard hose tail 45°

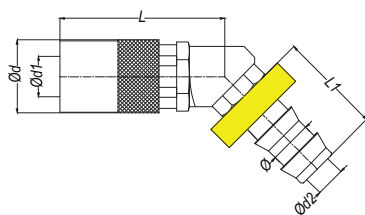

 / With Valve	 / Without Valve	Serie	Ø	Ød	Ød1	Ød2	L	L1
HVK 6-06-45°	HK 6-06-45°	200	6-1/4"	17	9.5	4	38.2	23.3
HVK 6-08-45°	HK 6-08-45°	200	8-5/16"	17	9.5	6	38.2	23.3
HVK 6-09-45°	HK 6-09-45°	200	9-5/14"	17	9.5	7	38.2	23.3
HVK 6-10-45°	HK6-10-45°	200	10-3/8"	17	9.5	8	38.2	23.3
HVK 9-10-45°	HK9-10-45°	300	10-3/8"	23.3	13.5	8	49.8	25.3
HVK 9-11-45°	HK 9-11-45°	300	11-7/16"	23.3	13.5	9	49.8	25.3
HVK 9-13-45°	HK9-13-45°	300	13-1/2"	23.3	13.5	10	49.8	25.3
HVK 16-13-45°	HK 16-13-45°	500	13-1/2"	32	20.1	12.8	73.5	27
HVK 16-16-45°	HK 16-16-45°	500	16-5/8"	32	20.1	15.5	73.5	27
HVK 16-19-45°	HK 16-19-45°	500	19-3/4"	32	20.1	18.5	73.5	27

with push-lock hose tail 45°



 / With Valve	 / Without Valve	Serie	Ø	Ød	Ød1	Ød2	L	L1
HVK 6 FG 06-45°	HK 6 FG 06-45°	200	6.7-1/4"	17	9.5	4.5	38.2	24
HVK 6 FG 10-45°	HK 6 FG 10-45°	200	10-3/8"	17	9.5	7.5	38.2	24
HVK 9 FG 10-45°	HK 9 FG 10-45°	300	10-3/8"	23.3	13.5	7.5	49.8	24
HVK 9 FG 13-45°	HK 9 FG 13-45°	300	13-1/2"	23.3	13.5	10	49.8	28
HVK 16 FG 13-45°	HK16 FG 13-45°	500	13.3-1/2"	32	20.1	9	73.5	28
HVK 16 FG 16-45°	HK16 FG 16-45°	500	16-5/8"	32	20.1	13	73.5	38
HVK 16 FG 19-45°	HK16 FG 19-45°	500	19-3/4"	32	20.1	15	73.5	38

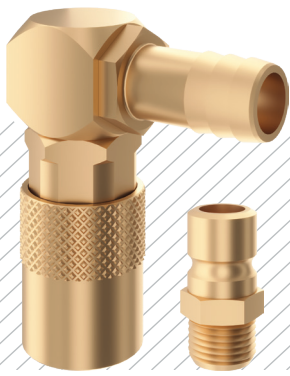

MOULD COOLING COUPLINGS  
KÜHLUNGSELEMENTE FÜR WERKZEUGE

# SERIE 6-9-16

## QUICK COUPLINGS SCHNELLKUPPLUNGEN

with male thread 90°

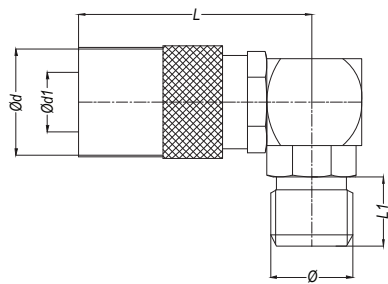

↻ / With Valve	← / Without Valve	Serie	Ø	Ød	Ød1	L	L1
HVK 6 EG 10-90°	HK 6 EG 10-90°	200	BSP 1/8"	17	9.5	37.2	9
HVK 6 EG 13-90°	HK 6 EG 13-90°	200	BSP 1/4"	17	9.5	37.2	11
HVK 9 EG 13-90°	HK 9 EG 13-90°	300	BSP 1/4"	23.3	13.5	50	11
HVK 9 EGM 16-90°	HK 9 EGM 16-90°	300	M16x1.5	23.3	13.5	50	11
HVK 9 EG 17-90°	HK 9 EG 17-90°	300	BSP 3/8"	23.3	13.5	50	11
HVK 9 EG 21-90°	HK 9 EG 21-90°	300	BSP 1/2"	23.3	13.5	50	11
HVK 16 EG 21-90°	HK 16 EG 21-90°	500	BSP 1/2"	32	20.1	73.5	12

with standard hose tail 90°

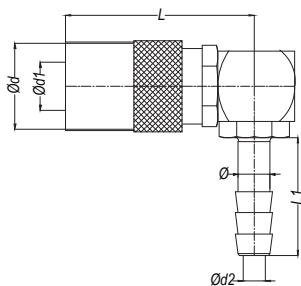

↻ / With Valve	← / Without Valve	Serie	Ø	Ød	Ød1	Ød2	L	L1
HVK 6-06-90°	HK 6-06-90°	200	6-1/4"	17	9.5	4	37.2	23.3
HVK 6-08-90°	HK 6-08-90°	200	8-5/16"	17	9.5	6	37.2	23.3
HVK 6-09-90°	HK 6-09-90°	200	9-5/14"	17	9.5	7	37.2	23.3
HVK 6-10-90°	HK 6-10-90°	200	10-3/8"	17	9.5	8	37.2	23.3
HVK 9-10-90°	HK 9-10-90°	300	10-3/8"	23.3	13.5	8	50	25.3
HVK 9-11-90°	HK 9-11-90°	300	11-7/16"	23.3	13.5	9	50	25.3
HVK 9-13-90°	HK 9-13-90°	300	13-1/2"	23.3	13.5	10	50	25.3
HVK 16-13-90°	HK 16-13-90°	500	13-1/2"	32	20.1	12.8	73	27
HVK 16-16-90°	HK 16-16-90°	500	16-5/8"	32	20.1	15.5	73	27
HVK 16-19-90°	HK 16-19-90°	500	19-3/4"	32	20.1	16.5	73	27

with push-lock hose tail 90°

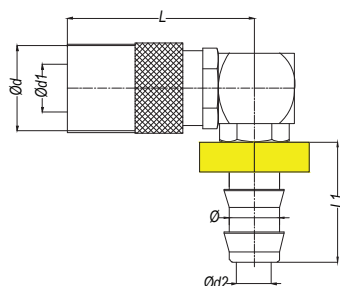

↻ / With Valve	← / Without Valve	Serie	Ø	Ød	Ød1	Ød2	L	L1
HVK 6 FG 06-90°	HK 6 FG 06-90°	200	6.7-1/4"	17	9.5	4.5	37.3	24
HVK 6 FG 10-90°	HK 6 FG 10-90°	200	10-3/8"	17	9.5	7.5	37.2	24
HVK 9 FG 10-90°	HK 9 FG 10-90°	300	10-3/8"	23.3	13.5	7.5	50	24
HVK 9 FG 13-90°	HK 9 FG 13-90°	300	13-1/2"	23.3	13.5	10	50	28
HVK 16 FG 13-90°	HK 16 FG 13-90°	500	13.3-1/2"	32	20.1	9	73	28
HVK 16 FG 16-90°	HK 16 FG 16-90°	500	16-5/8"	32	20.1	13	73	38
HVK 16 FG 19-90°	HK 16 FG 19-90°	500	19-3/4"	32	20.1	15	73	38

MOULD COOLING COUPLINGS

KÜHLUNGSELEMENTE FÜR WERKZEUGE

SERIE 6-9-16

QUICK COUPLINGS SCHNELLKUPPLUNGEN & PLUGS STECKNIPPEL

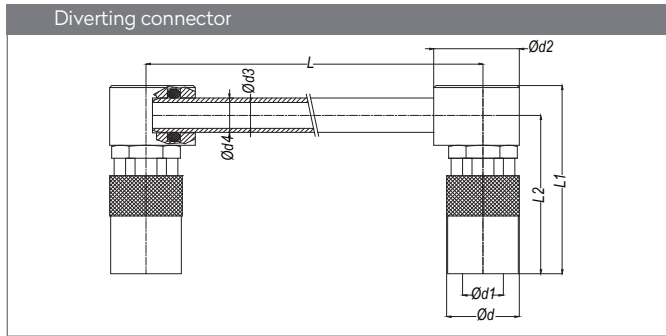

		↻	←								
With Valve	Without Valve	Serie	Ød	Ød1	Ød2	Ød3	Ød4	L	L1	L2	
HVK 6 - KG 125	HK 6 - KG 125	200	17	9.5	20	6	8	125	37	44.2	
HVK 6 - KG 250	HK 6 - KG 250	200	17	9.5	20	6	8	250	37	44.2	
HVK 6 - KG 500	HK 6 - KG 500	200	17	9.5	20	6	8	500	37	44.2	
HVK 9 - KG 125	HK 9 - KG 125	300	23.3	13.5	26	8	10	125	48.5	57	
HVK 9 - KG 250	HK 9 - KG 250	300	23.3	13.5	26	8	10	250	48.5	57	
HVK 9 - KG 500	HK 9 - KG 500	300	23.3	13.5	26	8	10	500	48.5	57	
HVK 16 - KG 160	HK 16 - KG 160	500	32	20.1	36	12	14	160	70.8	83.8	
HVK 16 - KG 315	HK 16 - KG 315	500	32	20.1	36	12	14	315	70.8	83.8	
HVK 16 - KG 500	HK 16 - KG 500	500	32	20.1	36	12	14	500	70.8	83.8	

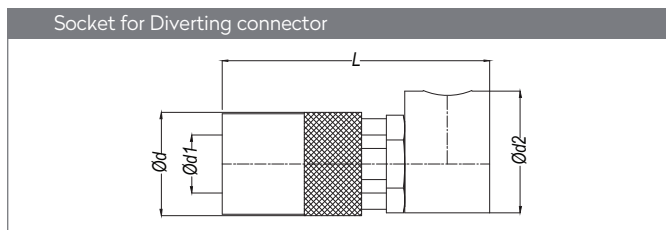

Part No.		Serie	Ød1	L	Ød	Ød2
HVK 6 KG 00	HK 6 KG 00	200	9.5	44.2	17	20
HVK 9 KG 00	HK 9 KG 00	300	13.5	57	23.3	26
HVK 16 KG 00	HK 16 KG 00	500	20.1	83.8	32	36

Part No. for the brass tube	Outer Ød	Thickness
060 KPB x Length	8	1
090 KPB x Length	10	1

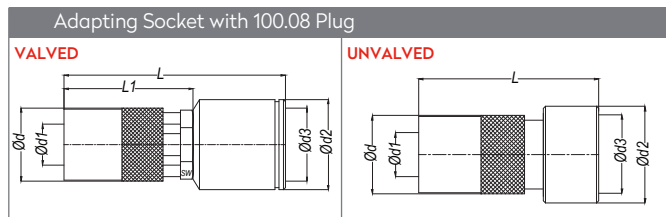

		↻	←							
With Valve	Without Valve	Serie	Ød	Ød1	Ød2	Ød3	L	L1	SW	
HVK 6 AU 100.08	-	200	17	9.5	21	17	51.6	30.1	14	
HVK 9 AU 100.08	-	300	23.3	13.5	21	17	52	40	19	
-	HK 6 AU 100.08	200	17	9.5	21	17	49	-	-	
-	HK 9 AU 100.08	300	23.3	13.5	21	17	48	-	-	

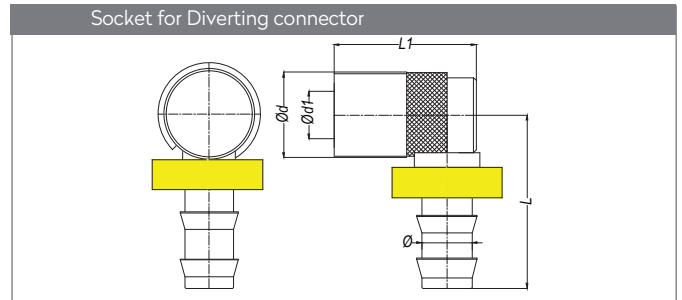

Part No.		Serie	Ø	L	L1	Ød	Ød1
HVK 6 KG 10	HK 6 KG 10	200	10 - 3/8"	34.5	28.3	17	9.5
HVK 9 KG 13	HK 9 KG 13	300	13 - 1/2"	41	36.3	23.3	13.5

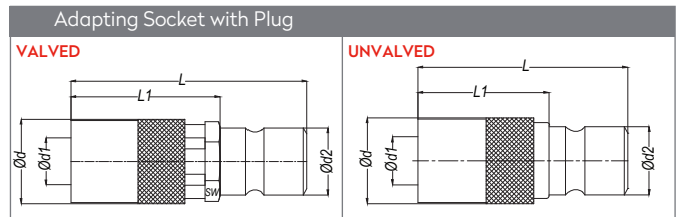

		↻	←							
With Valve	Without Valve	Serie	Ød	Ød1	Ød2	L	L1	SW		
HVK 6 AU 009	-	200	17	9.5	13.5	47.6	30.1	14		
HVK 9 AU 006	-	300	23.3	13.5	9.5	53	42.3	19		
-	HK 6 AU 009	200	17	9.5	13.5	41.6	26	-		
-	HK 9 AU 006	300	23.3	13.5	9.5	51	40	-		

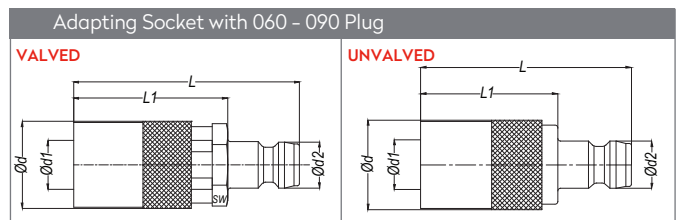

		↻	←							
With Valve	Without Valve	Serie	Ød	Ød1	Ød2	L	L1	SW		
HVK 6 AU 090	-	200	17	9.5	13.5	46	30.1	14		
HVK 9 AU 060	-	300	23.3	13.5	9.5	56.5	42.3	19		
-	HK 6 AU 090	200	17	9.5	9.5	40	26	-		
-	HK 9 AU 060	300	23.3	13.5	13.5	50	36.2	-		

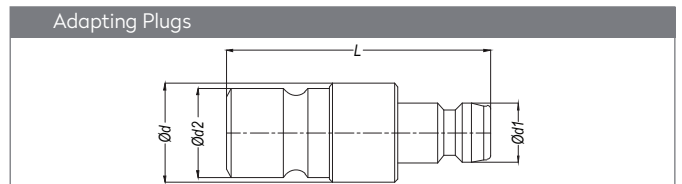

Part No.		Ød	Ød1	Ød2	L
006 HEF 00		11	9.4	9.4	30
009 HEF 00		15	13.5	13.5	40
006 HEF 009		15	9.4	13.5	35
006 HEF 060		11	9	9.4	35
009 HEF 090		15	13.5	13.5	40



MOULD COOLING COUPLINGS  
KÜHLUNGSELEMENTE FÜR WERKZEUGE

# SERIE 6-9-16

## PLUGS STECKNIPPEL

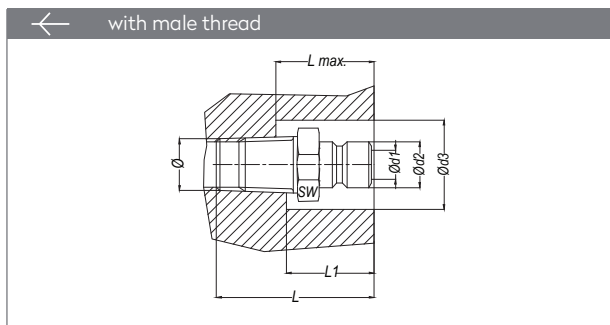

Part no.		Serie	Ø	Ød1	Ød2	Ød3	SW	L1	L <sub>max</sub>	L <sub>BSPT</sub>	L <sub>NPT</sub>
BSPT	NPT										
6 RU 10	6 TU 10	200	1/8"	6	9.4	22	11	17	18	24	24
6 RU 13	6 TU 13	200	1/4"	6	9.4	26	14	19	18	27	27
6 RU 17	6 TU 17	200	3/8"	6	9.4	30	17	21	22	27	27
6 RU 21	6 TU 21	200	1/2"	6	9.4	34	22	22	22	32	32
9 RU 10	9 TU 10	300	1/8"	9	13.5	26	14	26	24	29.5	29.5
9 RU 13	9 TU 13	300	1/4"	9	13.5	26	14	25	26	32.5	33
9 RU 17	9 TU 17	300	3/8"	9	13.5	30	17	26	28	32.5	34
9 RU 21	9 TU 21	300	1/2"	9	13.5	34	22	26	28	37	37
9 RU 26	9 TU 26	300	3/4"	9	13.5	30	17	26	36	42.5	42.5
16 RU 13	16 TU 13	500	1/4"	15	20	32	21	24.5	28	36.5	36.5
16 RU 17	16 TU 17	500	3/8"	15	20	32	21	24.5	29	37.5	37.5
16 RU 21	16 TU 21	500	1/2"	15	20	32	22	25.5	36	42.5	42.5
16 RU 26	16 TU 26	500	3/4"	15	20	32	27	26	36	43.8	43.8

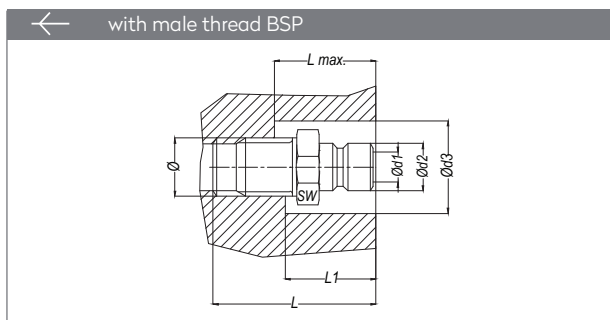

Part no.	Serie	Ø	Ød1	Ød2	Ød3	SW	L	L1	L <sub>max</sub>
6 EU 10	200	1/8"	6	9.4	22	11	22	17	18
6 EU 13	200	1/4"	6	9.4	26	14	27	19	18
6 EU 17	200	3/8"	6	9.4	30	17	27	21	22
9 EU 10	300	1/8"	9	13.5	26	14	27.5	25	25
9 EU 13	300	1/4"	9	13.5	26	14	29.5	25	25
9 EU 17	300	3/8"	9	13.5	32	19	29.5	26	26
9 EU 21	300	1/2"	9	13.5	34	22	32	26	26
16 EU 17	500	3/8"	15	20	36	21	35	26	26
16 EU 21	500	1/2"	15	20	37	22	37.5	25.5	25.5
6 EUM 10	200	M10x1	6	9.4	22	11	24	14	16
6 EUM 14	200	M14x1.5	6	9.4	26	15	25	14	16
9 EUM 10	300	M10x1	9	13.5	26	14	29.5	20	20
9 EUM 12	300	M12x1.5	9	13.5	26	14	29.5	20	20
9 EUM 14	300	M14x1.5	9	13.5	30	15	29.5	20	20

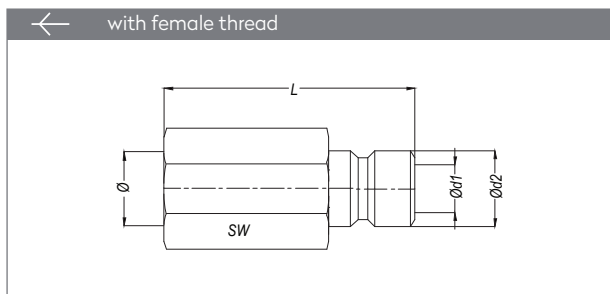

Part no.		Serie	Ø	Ød1	Ød2	L	SW
BSP	NPT						
6 DU 10	6 NU 10	200	1/8"	6	9.4	25.5	13
6 DU 13	6 NU 13	200	1/4"	6	9.4	32	16
6 DU 17	6 NU 17	200	3/8"	6	9.4	32	19
9 DU 10	9 NU 10	300	1/8"	9	13.5	29	14
9 DU 13	9 NU 13	300	1/4"	9	13.5	37	16
9 DU 17	9 NU 17	300	3/8"	9	13.5	39	19
9 DU 21	9 NU 21	300	1/2"	9	13.5	40	24
16 DU 17	16 NU 17	500	3/8"	15	20	34.5	24
16 DU 21	16 NU 21	500	1/2"	15	20	34.5	24

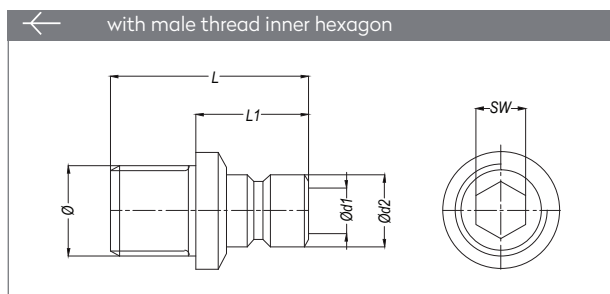

Part no.	Serie	Ø	Ød1	Ød2	L	L1	SW
6 AUG 13	200	1/4"	6	9.4	22.7	13.7	5
9 AUG 13	300	1/4"	9	13.5	30	20	8
9 AUG 17	300	3/8"	9	13.5	37	20.5	8

# MOULD COOLING COUPLINGS

## KÜHLUNGSELEMENTE FÜR WERKZEUGE

# SERIE 6-9-16



### PLUGS STECKNIPPEL

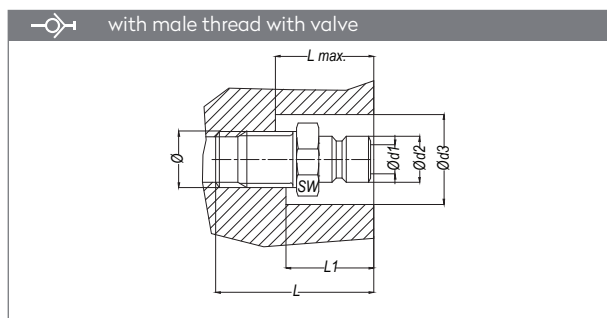
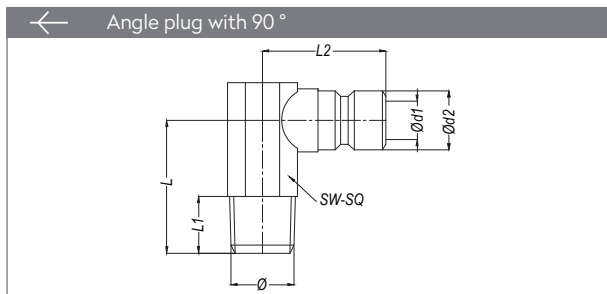
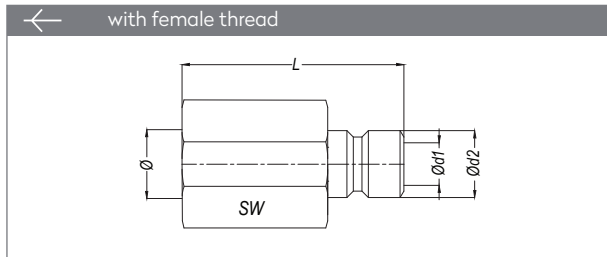
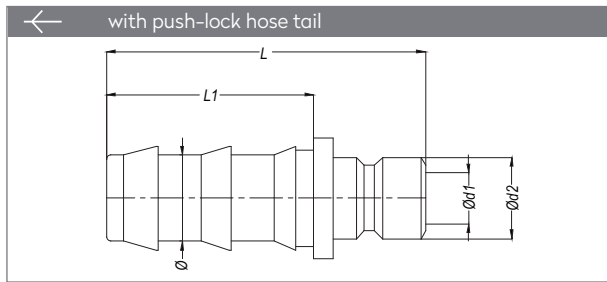
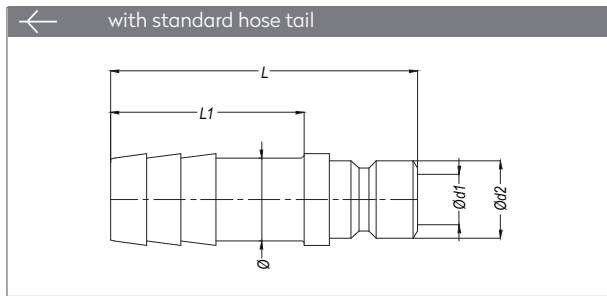

Part no.	Serie	Ø	Ød1	Ød2	L	L1
6 HU 06	200	6.3-1/4"	6	9.4	37	23.3
6 HU 08	200	8-5/16"	6	9.4	37	23.3
6 HU 09	200	9-5/14"	6	9.4	37	23.3
6 HU 10	200	10-3/8"	6	9.4	37	23.3
9 HU 09	300	9-5/14"	9	13.5	45	25.3
9 HU 10	300	10-3/8"	9	13.5	45	25.3
9 HU 11	300	11-7/16"	9	13.5	45	25.3
9 HU 13	300	13-1/4"	9	13.5	45	25.3
16 HU 13	500	13-1/4"	15	19.9	50	27
16 HU 19	500	19-3/4"	15	19.9	50	27

Part no.	Serie	Ø	Ød1	Ød2	L	L1
6 FU 10	200	10-3/8"	6	9.4	24	37
6 FU 13	200	13-1/2"	6	9.4	28	41
9 FU 06	300	6.3-1/2"	9	13.5	24	45
9 FU 10	300	10-3/8"	9	13.5	24	45
9 FU 13	300	13-1/2"	9	13.5	28	48
16 FU 19	500	19-3/4"	15	19.9	38	65

Part no.	Ø	Ød1	Ød2	SW	L1
006 DUB 10	BSP 1/8"	6	9.4	16	40.5
006 DUB 13	BSP 1/4"	6	9.4	19	40.5
009 DUB 13	BSP 1/4"	9	13.5	16	42.5
009 DUB 17	BSP 3/8"	9	13.5	19	42.5
009 DUB 21	BSP 1/2"	9	13.5	24	44.5
016 DUB 21	BSP 1/2"	15	20	24	62

Part no.	Serie	Ø	Ød1	Ød2	L	L1	L2	SW /SQ
6 RU 10 - 90	200	BSPT 1/8"	6	9.4	27	9	19.5	11
6 EUM 10 - 90	200	M10x1	6	9.4	27	9	19.5	11
6 RU 13 - 90	200	BSPT 1/4"	6	9.4	34	11	21.5	15
6 EUM 14 - 90	200	M14x1.5	6	9.4	34	11	21.5	15
6 RU 17 - 90	200	BSPT 3/8"	6	9.4	34	12	27	17
9 RU 13 - 90	300	BSPT 1/4"	9	13.5	34	11	27	15
9 RU 17 - 90	300	BSPT 3/8"	9	13.5	34	12	27.2	17

Part no.		Serie	Ø	Ød1	Ød2	Ød3	L	L1	L max.	SW
BSPT	NPT									
6 RUB 13	6 TUB 13	200	1/4"	6	9.4	26	29	15	24	14
6 RUB 17	6 TUB 17	200	3/8"	6	9.4	30	29	15	24	17
9 RUB 13	9 TUB 13	300	1/4"	9	13.5	26	32.5	20.5	24	14
9 RUB 17	9 TUB 17	300	3/8"	9	13.5	30	32.5	20.5	24	17
9 RUB 21	9 TUB 21	300	1/2"	9	13.5	37	37	21	30	22
16 RUB 21	16 TUB 21	500	1/2"	15	20	32	45.5	26.7	36	22
16 RUB 26	16 TUB 26	500	3/4"	15	20	32	45.5	26.7	36	27

Part no.	Serie	Ø	Ød1	Ød2	Ød3	L	L1	L max.	SW
6 EUBM 10	200	M10x1	6	9.4	26	28.5	18	22	14
6 EUBM 14	200	M14x1.5	6	9.4	26	29	15	15	14
9 EUBM 14	300	M14x1.5	9	13.5	26	30	20	20	14



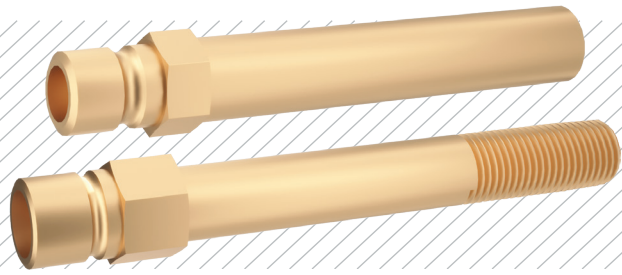

MOULD COOLING COUPLINGS  
KÜHLUNGSELEMENTE FÜR WERKZEUGE

# SERIE 6-9-16

## PLUGS STECKNIPPEL

- Extension Plugs with tapered and long parallel thread  
Verlängerungsniessel mit Aussengewinde konisch
- The largest complete thread on the standard NPT or BSPT taper is continued along the extension plug for the 1 5/8" (41 mm) shown below easy adjustments if needed.  
Die erste Gewindestufe der konisch ausgeführten Niessel ermöglicht einen sehr flexiblen Einsatzbereich

Serie	Ød1	Ød2
200	6	9.4
300	9	13.5
500	15	19.9

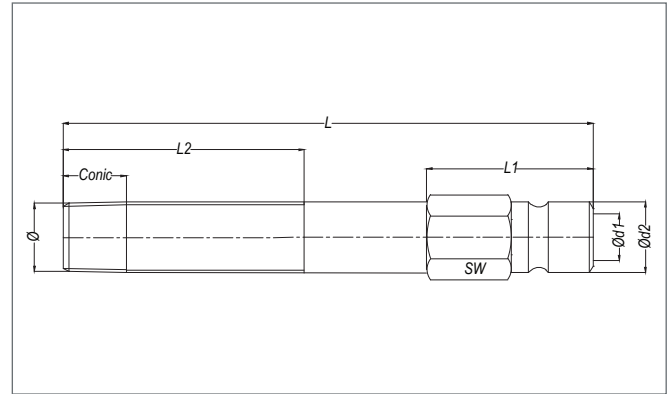

Serie & Thread	Part No.		L	L1	L2	SW
	NPT	BSPT				
200 1/8"	6 RL 10x63	6 NL 10x63	63.5	21.2	41	11
	6 RL 10x101	6 NL 10x101	101.6	25.4	41	11
	6 RL 10x140	6 NL 10x140	140	25.4	41	11
	6 RL 10x178	6 NL 10x178	178	25.4	41	11
	6 RL 10x216	6 NL 10x216	216	25.4	41	11
	6 RL 10x254	6 NL 10x254	254	25.4	41	11
	6 RL 10x292	6 NL 10x292	292	25.4	41	11
200 1/4"	6 RL 10x330	6 NL 10x330	330	25.4	41	11
	6 RL 13x63	6 NL 13x63	63.5	22.2	41	14
	6 RL 13x101	6 NL 13x101	101.6	31.7	41	14
	6 RL 13x140	6 NL 13x140	140	31.7	41	14
	6 RL 13x178	6 NL 13x178	178	31.7	41	14
	6 RL 13x216	6 NL 13x216	216	31.7	41	14
	6 RL 13x254	6 NL 13x254	254	31.7	41	14
200 3/8"	6 RL 13x292	6 NL 13x292	292	31.7	41	14
	6 RL 13x330	6 NL 13x330	330	31.7	41	14
	6 RL 17x63	6 NL 17x63	63.5	25.4	41	17
	6 RL 17x101	6 NL 17x101	101.6	31.7	41	17
	6 RL 17x140	6 NL 17x140	140	31.7	41	17
	6 RL 17x178	6 NL 17x178	178	31.7	41	17
	6 RL 17x216	6 NL 17x216	216	31.7	41	17
300 1/8"	6 RL 17x254	6 NL 17x254	254	31.7	41	17
	6 RL 17x292	6 NL 17x292	292	31.7	41	17
	6 RL 17x330	6 NL 17x330	330	31.7	41	17
	9 RL 10x63	9 NL 10x63	63.5	21	38.1	14
	9 RL 10x101	9 NL 10x101	101.6	22.2	41.5	14
	9 RL 10x140	9 NL 10x140	140	25.4	41.5	14
	9 RL 10x178	9 NL 10x178	178	25.4	41.5	14
300 1/4"	9 RL 10x216	9 NL 10x216	216	25.4	41.5	14
	9 RL 10x254	9 NL 10x254	254	25.4	41.5	14
	9 RL 10x292	9 NL 10x292	292	25.4	41.5	14
	9 RL 10x330	9 NL 10x330	330	25.4	41.5	14
	16 RL 17x63	16 NL 17x63	63.5	25.4	42	21
	16 RL 17x101	16 NL 17x101	101.6	38.1	42	21
	16 RL 17x140	16 NL 17x140	140	38.1	42	21
500 3/8"	16 RL 17x178	16 NL 17x178	178	38.1	42	21
	16 RL 17x216	16 NL 17x216	216	38.1	42	21
	16 RL 17x254	16 NL 17x254	254	38.1	42	21
	16 RL 17x292	16 NL 17x292	292	38.1	42	21
	16 RL 17x330	16 NL 17x330	330	38.1	42	21
	16 RL 21x63	16 NL 21x63	63.5	25.4	42	22
	16 RL 21x101	16 NL 21x101	101.6	38.1	42	22
500 1/2"	16 RL 21x140	16 NL 21x140	140	38.1	42	22
	16 RL 21x178	16 NL 21x178	178	38.1	42	22
	16 RL 21x216	16 NL 21x216	216	38.1	42	22
	16 RL 21x254	16 NL 21x254	254	38.1	42	22
	16 RL 21x292	16 NL 21x292	292	38.1	42	22
	16 RL 21x330	16 NL 21x330	330	38.1	42	22
	16 RL 21x330	16 NL 21x330	330	38.1	42	22

Serie & Thread	Part No.		L	L1	L2	SW <sub>NPT</sub>	SW <sub>BSPT</sub>
	NPT	BSPT					
300 1/4"	9 RL 13x63	9 NL 13x63	63.5	22.2	41.5	14	14
	9 RL 13x101	9 NL 13x101	101.6	31.7	41.5	14	14
	9 RL 13x140	9 NL 13x140	140	31.7	41.5	15	14
	9 RL 13x178	9 NL 13x178	178	31.7	41.5	15	14
	9 RL 13x216	9 NL 13x216	216	31.7	41.5	15	14
	9 RL 13x254	9 NL 13x254	254	31.7	41.5	15	14
	9 RL 13x292	9 NL 13x292	292	31.7	41.5	15	14
300 3/8"	9 RL 13x330	9 NL 13x330	330	31.7	41.5	15	14
	9 RL 17x63	9 NL 17x63	63.5	25.4	38.1	17	17
	9 RL 17x101	9 NL 17x101	101.6	31.7	38.1	17	17
	9 RL 17x140	9 NL 17x140	140	31.7	38.1	17	17
	9 RL 17x178	9 NL 17x178	178	31.7	38.1	17	17
	9 RL 17x216	9 NL 17x216	216	31.7	38.1	17	17
	9 RL 17x254	9 NL 17x254	254	31.7	38.1	17	17
300 1/2"	9 RL 17x292	9 NL 17x292	292	31.7	38.1	17	17
	9 RL 17x330	9 NL 17x330	330	31.7	41.5	17	17
	9 RL 21x63	9 NL 21x63	63.5	25.4	38.1	22	22
	9 RL 21x101	9 NL 21x101	101.6	31.7	38.1	22	22
	9 RL 21x140	9 NL 21x140	140	31.7	38.1	22	22
	9 RL 21x178	9 NL 21x178	178	31.7	38.1	22	22
	9 RL 21x216	9 NL 21x216	216	31.7	38.1	22	22
500 3/8"	9 RL 21x254	9 NL 21x254	254	31.7	38.1	22	22
	9 RL 21x292	9 NL 21x292	292	31.7	38.1	22	22
	9 RL 21x330	9 NL 21x330	330	31.7	38.1	22	22
	16 RL 17x63	16 NL 17x63	63.5	25.4	42	21	21
	16 RL 17x101	16 NL 17x101	101.6	38.1	42	21	21
	16 RL 17x140	16 NL 17x140	140	38.1	42	21	21
	16 RL 17x178	16 NL 17x178	178	38.1	42	21	21
500 1/2"	16 RL 17x216	16 NL 17x216	216	38.1	42	21	21
	16 RL 17x254	16 NL 17x254	254	38.1	42	21	21
	16 RL 17x292	16 NL 17x292	292	38.1	42	21	21
	16 RL 17x330	16 NL 17x330	330	38.1	42	21	21
	16 RL 21x63	16 NL 21x63	63.5	25.4	42	22	22
	16 RL 21x101	16 NL 21x101	101.6	38.1	42	22	22
	16 RL 21x140	16 NL 21x140	140	38.1	42	22	22
500 1/2"	16 RL 21x178	16 NL 21x178	178	38.1	42	22	22
	16 RL 21x216	16 NL 21x216	216	38.1	42	22	22
	16 RL 21x254	16 NL 21x254	254	38.1	42	22	22
	16 RL 21x292	16 NL 21x292	292	38.1	42	22	22
	16 RL 21x330	16 NL 21x330	330	38.1	42	22	22
	16 RL 21x330	16 NL 21x330	330	38.1	42	22	22
	16 RL 21x330	16 NL 21x330	330	38.1	42	22	22

# MOULD COOLING COUPLINGS

## KÜHLUNGSELEMENTE FÜR WERKZEUGE

# SERIE 6-9-16

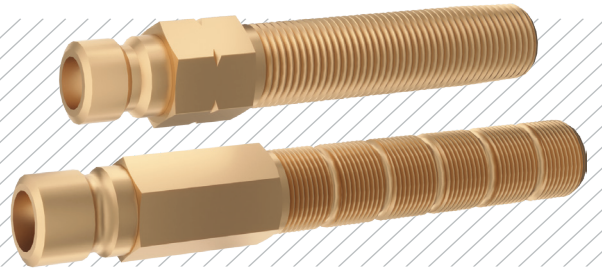

### PLUGS STECKNIPPEL

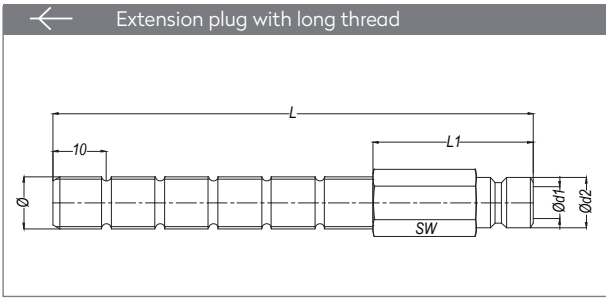

Part no.	Serie	Ø	Ød1	Ød2	SW	L	L1
6 BLM 10x100	200	M10x1	6	9.4	11	100	40
6 BL 10x100	200	BSP 1/8"	6	9.4	11	100	40
6 BL 13x100	200	BSP 1/4"	6	9.4	14	100	40
6 BLM 14x100	200	M14x1.5	6	9.4	14	100	40
6 BL 17x100	200	BSP 3/8"	6	9.4	17	100	40
9 BLM 10x100	300	M10x1	9	13.5	14	100	40
9 BL 10x100	300	BSP 1/8"	9	13.5	14	100	40
9 BL 13x100	300	BSP 1/4"	9	13.5	14	100	40
9 BLM 14x100	300	M14x1.5	9	13.5	14	100	40
9 BLM 16x100	300	M16x1.5	9	13.5	16	100	40
9 BL 17x100	300	BSP 3/8"	9	13.5	17	100	40

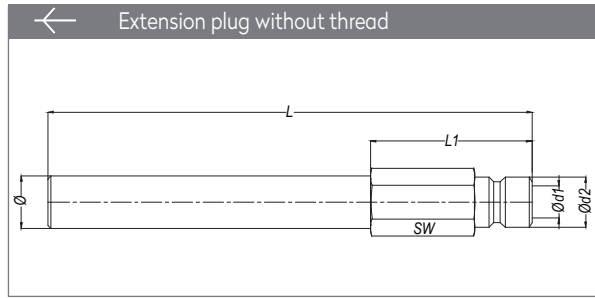

Part no.	Serie	Ø	Ød1	Ød2	SW	L	L1
6 BN 63	200	10	6	9.4	11	63	17
6 BN 100	200	10	6	9.4	11	100	17
6 BN 120	200	10	6	9.4	11	120	17
6 BN 240	200	10	6	9.4	11	240	17
6 BN 360	200	10	6	9.4	11	360	17
9 BN 150	300	14	9	13.5	15	150	23.5
9 BN 300	300	14	9	13.5	15	300	23.5
9 BN 450	300	14	9	13.5	15	450	24

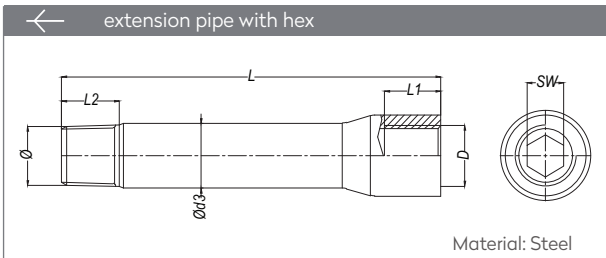

Part no.	D	Ø	Ød3	L	L1	L2	SW
R 10 BU 50	BSP 1/8"	BSPT 1/8"	10	50	9	10	5
R 10 BU 75	BSP 1/8"	BSPT 1/8"	10	75	9	10	5
R 10 BU 100	BSP 1/8"	BSPT 1/8"	10	100	9	10	5
R 10 BU 125	BSP 1/8"	BSPT 1/8"	10	125	9	10	5
R 10 BU 150	BSP 1/8"	BSPT 1/8"	10	150	9	10	5
N 10 BU 50	NPT 1/8"	NPSF 1/8"	10	50	9	10	5
N 10 BU 75	NPT 1/8"	NPSF 1/8"	10	75	9	10	5
N 10 BU 100	NPT 1/8"	NPSF 1/8"	10	100	9	10	5
N 10 BU 125	NPT 1/8"	NPSF 1/8"	10	125	9	10	5
N 10 BU 150	NPT 1/8"	NPSF 1/8"	10	150	9	10	5
R 13 BU 50	BSP 1/4"	BSPT 1/4"	14	50	12	11	8
R 13 BU 75	BSP 1/4"	BSPT 1/4"	14	75	12	11	8
R 13 BU 100	BSP 1/4"	BSPT 1/4"	14	100	12	11	8
R 13 BU 125	BSP 1/4"	BSPT 1/4"	14	125	12	11	8
R 13 BU 150	BSP 1/4"	BSPT 1/4"	14	150	12	11	8
R 13 BU 200	BSP 1/4"	BSPT 1/4"	14	200	12	11	8
N 13 BU 50	BSP 1/4"	NPT 1/4"	14	50	12	11	8
N 13 BU 75	BSP 1/4"	NPT 1/4"	14	75	12	11	8
R 13 BU 100	BSP 1/4"	NPT 1/4"	14	100	12	11	8
R 13 BU 125	BSP 1/4"	NPT 1/4"	14	125	12	11	8
R 13 BU 150	BSP 1/4"	NPT 1/4"	14	150	12	11	8
R 13 BU 200	BSP 1/4"	NPT 1/4"	14	200	12	11	8

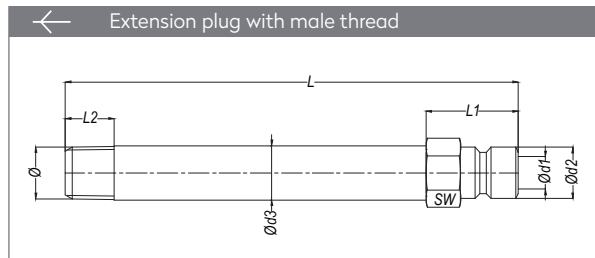

Part no.		Serie	Ø	SW	Ød1	Ød2	Ød3	L1	L2	L50	L100	L150	L200	L250
BSPT	NPT													
6 RU 10xL	6 TU 10xL	200	1/8"	11	6	9.4	10	17	9	50	100	150	200	250
6 RU 13xL	6 TU 13xL	200	1/4"	14	6	9.4	14	17	12	50	100	150	200	250
6 RU 17xL	6 TU 17xL	200	3/8"	17	6	9.4	16.8	17	12	50	100	150	200	250
9 RU 10xL	9 TU 10xL	300	1/8"	14	9	13.5	10	24	9	50	100	150	200	250
9 RU 13xL	9 TU 13xL	300	1/4"	15	9	13.5	14	24	12	50	100	150	200	250
9 RU 17xL	9 TU 17xL	300	3/8"	17	9	13.5	16.8	24	12	50	100	150	200	250
9 RU 21xL	9 TU 21xL	300	1/2"	22	9	13.5	21.4	24	14	50	100	150	200	250
Part No.	Serie	Ø	SW	Ød1	Ød2	Ød3	L1	L2	L50	L100	L150	L200	L250	
6 EUM 10xL	200	M10x1	11	6	9	10	17	9	50	100	150	200	250	
6 EUM 14xL	200	M14x1.5	15	6	9	14	17	12	50	100	150	200	250	
9 EUM 14xL	300	M14x1.5	15	9	13	14	24	12	50	100	150	200	250	

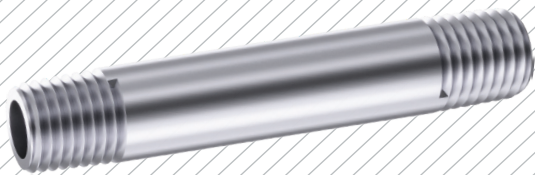

MOULD COOLING COUPLINGS  
KÜHLUNGSELEMENTE FÜR WERKZEUGE

# SERIE 6-9-16

## PLUGS STECKNIPPEL

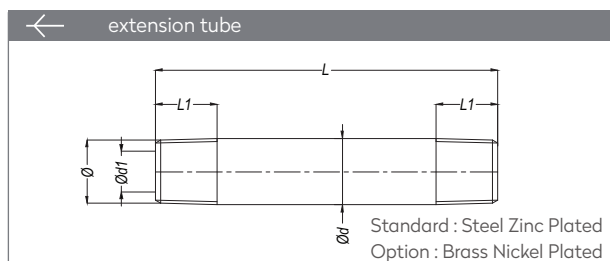

Part no.		Ø	Ød	Ød1	L	L1
BSPT	NPT					
6 BU 50	6 NBU 50	1/8"	10	6	50	9
6 BU 100	6 NBU 100	1/8"	10	6	100	9
6 BU 150	6 NBU 150	1/8"	10	6	150	9
6 BU 200	6 NBU 200	1/8"	10	6	200	9
6 BU 250	6 NBU 250	1/8"	10	6	250	9
6 BU 300	6 NBU 300	1/8"	10	6	300	9
9 BU 50	9 NBU 50	1/4"	14	9	50	11
9 BU 100	9 NBU 100	1/4"	14	9	100	11
9 BU 150	9 NBU 150	1/4"	14	9	150	11
9 BU 200	9 NBU 200	1/4"	14	9	200	11
9 BU 250	9 NBU 250	1/4"	14	9	250	11
9 BU 300	9 NBU 300	1/4"	14	9	300	11
9 BU 350	9 NBU 350	1/4"	14	9	350	11
12 BU 30	12 NBU 30	3/8"	17	12	30	12
12 BU 350	12 NBU 350	3/8"	17	12	350	12
16 BU 100	16 NBU 100	1/2"	22	16	100	15
16 BU 150	16 NBU 150	1/2"	22	16	150	15
16 BU 200	16 NBU 200	1/2"	22	16	200	15
16 BU 250	16 NBU 250	1/2"	22	16	250	15

## ACCESSORIES ZUBEHÖR



Part No.	Serie	Temperature
006GC00M	200	
009GC00M	300	-40°C to + 100°C
016GC00M	500	

Part No.	Serie	Temperature
006GC00V	200	
009GC00V	300	-26°C to + 200°C
016GC00V	500	

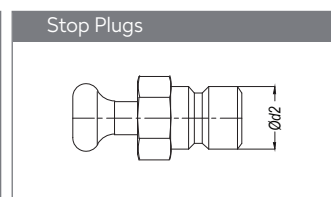
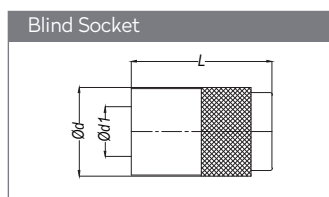

Part No.	Serie	Ød	Ød1	L
6 KTG 00	200	17	9.5	27
9 KTG 00	300	23.3	13.5	36
16 KTG 00	500	32	20.1	44.5

Part No.	Serie	Ød2
6 KTU 00	200 (1/4")	9.4
9 KTU 00	300 (3/8")	13.5
16 KTU 00	500 (1/2")	19.9

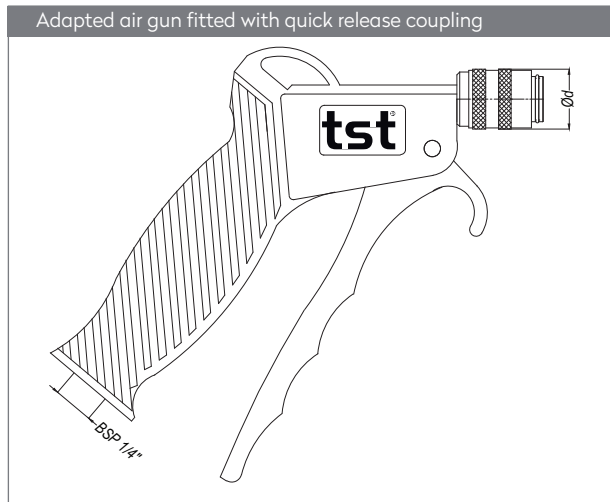

Part No.	Ød
TSW00 - 060	18

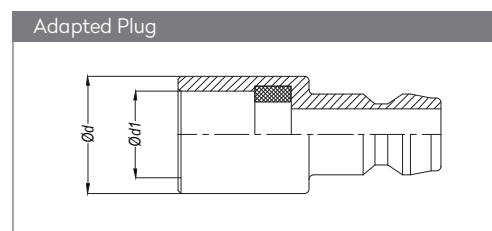

Part No.	Ød	Ød1	L
6 HTU 060	14	9.5	28.5
9 HTU 060	18	13.5	35