

QUICK COUPLINGS

SWING COUPLING / SV SERIE / STAINLESS STEEL SERIE



tst[®]

SMART SOLUTIONS FOR INDUSTRIAL CONNECTIONS



Swing Couplings SC

Product Chart

EN

Safely swing to connect

With full flow. No force required or loss of pressure in the system. Just a turn and the air vent ensures that the hose is ventilated – thus rendering it harmless.

TST Swing Couplings SC are available in nominal sizes DN6 to DN19 and in different models. They are compatible with most popular plug systems. The many different types and models and a wide choice of seals and lubricants mean that TST Couplings are suitable for numerous applications throughout industry. Durability, reliability, simple and safe handling are features of all TST Swing Couplings.

TST Swing Couplings fulfill all the requirements of current quality standards and have also been awarded a type examination certificate from the Swiss Accident Insurance Institute SUVA.

DE

Jederzeit gefahrlos kuppeln durch Schwenken

Mit vollem Durchgang. Ohne Kraftaufwand und Druckabfall im System. Nur ein Schwenk und der ausgekuppelte Schlauch wird dank Entlüftungsbohrung sofort drucklos und damit gefahrlos.

TST Schwenk-Kupplungen SC sind in Nennweiten von DN6 bis DN19 und in verschiedenen Ausführungen erhältlich. Kompatibel mit allen gängigen Stecknippelsystemen. Dank einer Auswahl an Spezialdichtungen und Schmiermitteln eignen sich TST Schwenk-Kupplungen für vielfältige Anwendungen in allen Branchen und Bereichen.

Lange Lebensdauer, Zuverlässigkeit, einfache und sichere Handhabung sind die Merkmale aller TST Schwenk-Kupplungen. TST Schwenk-Kupplungen erfüllen sämtliche Anforderungen heute gültiger Qualitätsnormen und verfügen über die Baumusterbescheinigung der Schweiz. Unfallversicherungsanstalt SUVA.

FR

Accouplement sans risque par pivotement

Passage intégral. Sans effort ni perte de pression dans le circuit. Un simple pivotement et le tuyau est instantanément hors pression (grâce à l'évent de purge) et donc sans danger.

Les coupleurs pivotants SC TST sont livrables en diamètres nominaux de DN6 à DN19 et en différentes exécutions. Ils sont compatibles avec la plupart des systèmes d'about existant sur le marché. Grâce à un choix étendu de joints spéciaux et de lubrifiants, les coupleurs pivotants TST sont adaptés à de nombreuses applications dans tous les secteurs industriels.

Longévité, fiabilité, manipulation simple et sûre sont les caractéristiques des coupleurs pivotants TST. Les coupleurs pivotants TST répondent à toutes les exigences actuelles en matière de qualité et ont obtenu l'attestation de type de la caisse nationale suisse d'assurance en cas d'accidents SUVA.

NL

Altijd zonder gevaar aan- en afkoppelen door te knikken

Met volledige doorlaat. Zonder krachtsinspanning en drukval in het systeem. Slechts één knik en de te ontkoppelen slang wordt dankzij het ontluftingsgat meteen drukloos, en daarmee ongevaarlijk.

TST knikkoppelingen SC zijn in de doorlaten DN6 tot en met DN19 en in verschillende uitvoeringen verkrijgbaar. Uitwisselbaar met de meeste gangbare insteeknippelsystemen. Dankzij de keuze aan speciale afdichtingen en smeermiddelen zijn de TST knikkoppelingen geschikt voor veel verschillende toepassingen in allerlei bedrijfstakken.

Lange levensduur, betrouwbaarheid, eenvoudige en veilige bediening vormen het handelsmerk van alle TST knikkoppelingen. TST knikkoppelingen voldoen aan alle huidige geldende eisen van kwaliteitsnormen en beschikken over het Arbeidsveiligheidsattest van de Zwitserse Ongevallenverzekeringinstelling SUVA.

Swing Couplings SC

Product Overview



DN6
1/4"

- Series A1
- Series B1
- Series K
- Series N
- Series P

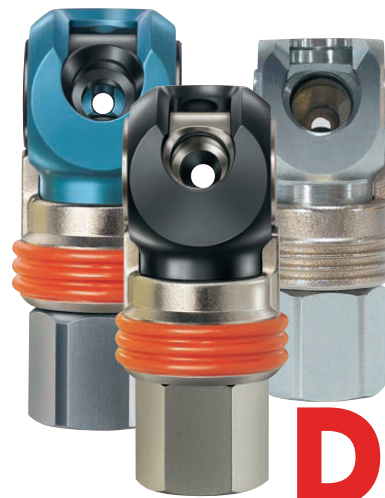

DN8
3/8"

- Series C
- Series D
- Series DL
- Series E
- Series E1
- Series M
- Series J



DN11
1/2"

- Series G
- Series H
- Series HB



DN19
3/4" Series I

Swing Couplings SC

Swing to Connect

Simple and quick connection with no force or loss of pressure in the system

EN

Connection

- Push suitable plug into coupling and swing approximately 90° until the orange ring engages in the groove.

DE

Einkuppeln

- Passenden Stecknippel in die Kupplung einstecken und ca. 90° schwenken, bis der orange Ring in der vorgesehenen Nut einrastet.

FR

Accouplement

- Engager l'about adapté dans le coupleur et le pivoter d'environ 90° jusqu'à ce que le barillet soit bloqué par l'ergot de la bague orange.

NL

Aankoppelen

- Een passende insteeknippel in de koppeling steken en ca. 90° knikken, tot de oranje ring in de daarvoor uitgespaarde borging klikt.

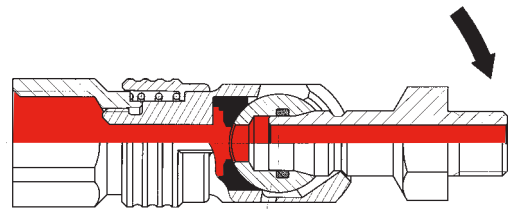
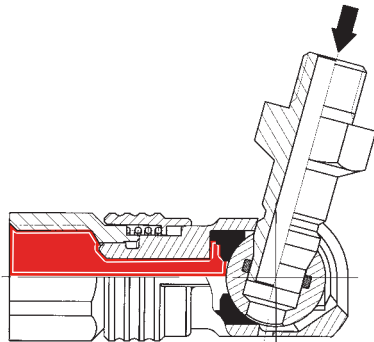

Full flow with no restrictions.

EN

Disconnection

- Pull back orange ring and swing plug to stop. Remove plug from coupling.

DE

Auskuppeln

- Orangen Ring zurückstossen und Stecknippel bis zum Anschlag schwenken, Stecknippel aus der Kupplung ziehen.

FR

Désaccouplement

- Tirer la bague orange vers l'arrière pour dégager le barillet et pivoter l'about jusqu'au point de butée, puis désengager l'about du barillet.

NL

Afkoppelen

- De oranje ring terugschuiven en de insteeknippel tot de aanslag terugknikken, de insteeknippel uit de koppeling trekken.

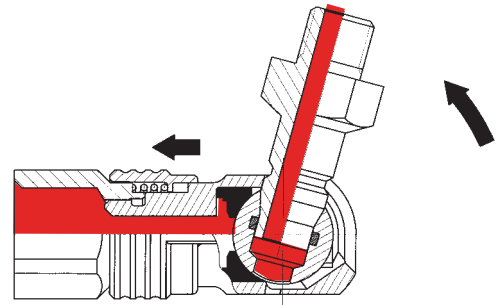
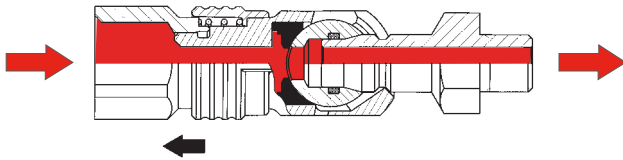

EN

Disconnection

- In order to prevent the hose from ejecting dangerously, the plug must be held in the hand until the hose is completely ventilated.

DE

Auskuppeln

- Um ein gefährliches Rückschlagen des Schlauches zu vermeiden, muss der Stecknippel so lange in der Hand gehalten werden, bis der Schlauch vollständig entlüftet ist.

FR

Désaccouplement

- Pour éviter un coup de fouet du tuyau, il convient de garder l'about en main jusqu'à ce que le tuyau soit entièrement purgé.

NL

Afkoppelen

- Om een gevaarlijke terugslag van de slang te vermijden, moet de insteeknippel in de hand gehouden worden tot de slang volledig ont- lucht is.

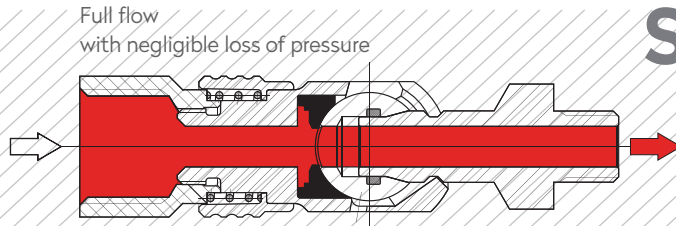

Swing Couplings SC

Swing to Connect

More efficient, low energy consumption and safe



EN

The new generation of TST Couplings, the valveless SC coupling model—result of innovative development and many years of experience—free flow guaranteed in every case. When using compressed air operated equipment, for instance, in conjunction with TST Swing Couplings SC, the result will always be a method of operation which is more efficient with low energy consumption, thus making it very economical.

Application

Throughput media

Compressed air, gases, liquids and media with low to medium viscosity due to free flow with no restrictions. Easy to clean.

DE

Die neue TST Kupplungs-Generation, des ventillosen Kupplungs-Typs SC ist das Ergebnis innovativer Entwicklung und langjähriger Erfahrung und garantiert in jedem Fall vollen Durchgang. So ist z.B. beim Betrieb druckluftbetriebener Geräte in Verbindung mit TST Schwenk-Kupplungen SC eine effizientere, energiesparendere und somit wirtschaftlichere Wirkungsweise die Folge.

Anwendungsbereich

Durchflussmedien

Druckluft, Gase, Flüssigkeiten und Medien mit niedriger bis mittlerer Viskosität dank freiem Durchgang ohne Umlenkung. Leicht zu reinigen.

FR

La nouvelle génération des coupleurs TST, les coupleurs pivotants SC sans valve – résultat d'un développement innovant et de nombreuses années d'expérience – garantit dans tous les cas un passage intégral. Ainsi l'utilisation d'un outillage pneumatique connecté au réseau par l'intermédiaire d'un coupleur pivotant SC TST se révèle-t-elle plus efficace, économe en énergie, et par conséquent plus rentable.

Domaine d'application

Fluides véhiculés

Air comprimé, gaz, liquides et substances de viscosité faible à moyenne grâce au passage libre sans déviation du flux. Facile à nettoyer.

NL

Het resultaat van innovatieve ontwikkeling en jarenlange ervaring is de nieuwe generatie TST koppelingen, het SC type zonder klep – deze garandeert bij ieder gebruik een volledige doorlaat. Zo ontstaat bij het gebruik van b.v. luchtgereedschap verbonden door de TST knikkoppeling SC een werkwijze die efficiënter, energiebesparend en daarmee ook economisch verantwoord is.

Toepassingsgebied

Doorstroommedia

Drukluft, gassen, vloeistoffen en media met lage tot gemiddelde viscositeit dankzij een vrije doorlaat zonder omleiding. Gemakkelijk te reinigen

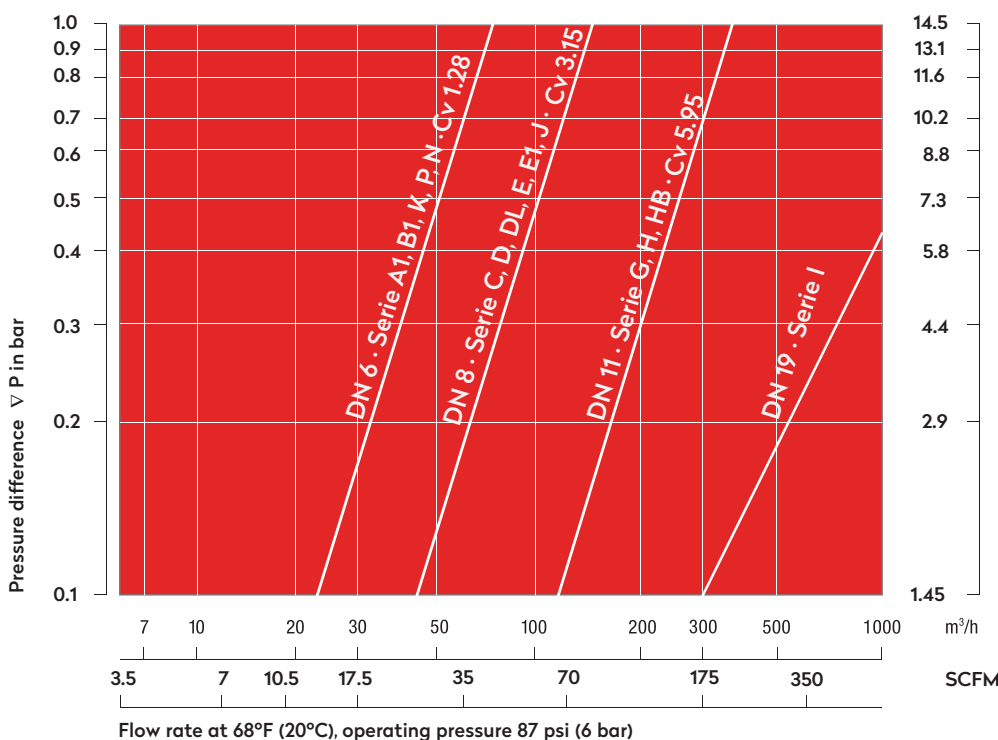

Cross Section Model SC

Swing Couplings SC

Plug Profiles

Full compatibility with most popular plug systems

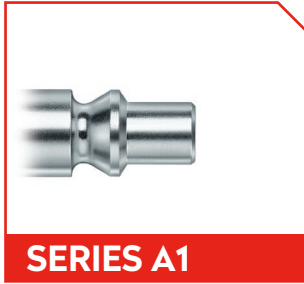

SERIES A1

DN	TST	014, 022
	AMFLO	C38
	ARO	210
	Cejn	300
	Foster	210
	Parker	B53
	Rectus	14, 22
6 mm		
1/4"		

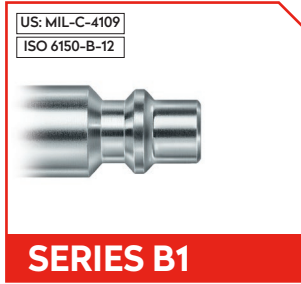

SERIES B1

US: MIL-C-4109		
ISO 6150-B-12		
DN	TST	023, 024
	Industrial Interchange	1/4"
	AMFLO	C20B
	Hansen	1000
	Foster	3003
	Parker	B23
	Cejn	310
6 mm		
1/4"		



SERIES K

ISO 6150-C-10		
DN	TST	107, 06
	TST	018
	TST	SV - DN 6
	Rectus	18
	Cejn	291
6 mm		
1/4"		



SERIES N

Spanish Profile		
DN	Imopac	CD25, -S, -N
6 mm		
1/4"		

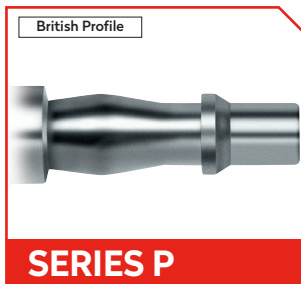

SERIES P

British Profile		
DN	TST	019
	PCL	AC21, AC29, AC91
6 mm		
1/4"		

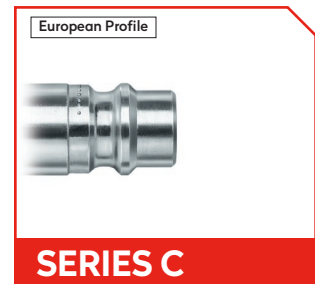

SERIES C

European Profile		
DN	TST	025, 026
	Cejn	320
	Rectus	25, 26
8 mm		
3/8"		

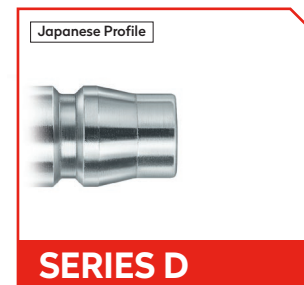

SERIES D

Japanese Profile		
DN	TST	013
	Nitto	20, 30, 40
	Cejn	315
	Rectus	13
8 mm		
3/8"		

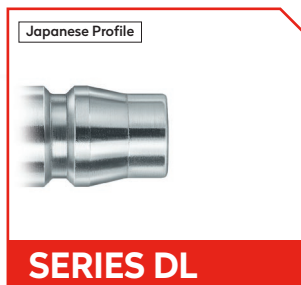

SERIES DL

Japanese Profile		
DN	TST	013
	Nitto	20, 30, 40
	Cejn	315
	Rectus	13
8 mm		
3/8"		

Swing Couplings SC Plug Profiles

Full compatibility with most popular plug systems



US: MIL-C-4109
ISO 6150-B-15

SERIES E

DN	TST	030
	Industrial Interchange	3/8"
	AMFLO	C26
	Cejn	430
	Hansen	440
	Foster	4404
	Rectus	30
	8 mm	
	3/8"	



ISO 6150-C-14

SERIES E1

DN	TST	107.08
	TST	SV - DN 8
	8 mm	
	3/8"	



US: MIL-C-4109
ISO 6150-B-15

SERIES M

DN	TST	095, 096
	Cejn	344, *342
	Rectus	95 KS, *96 KS
	8 mm	* Coupling only
	3/8"	

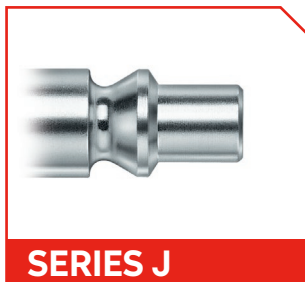

SERIES J

DN	TST	040
	ARO	310
	Orion	44530
	Rectus	40
	8 mm	
	3/8"	



US: MIL-C-4109
ISO 6150-B-17

SERIES H

DN	TST	037
	Industrial Interchange	1/2"
	AMFLO	C10
	Hansen	520
	Foster	5205
	1/2"	Parker 17
	11 mm	
	1/2"	



US: MIL-C-4109
ISO 6150-B-17

SERIES HB

DN	TST	037
	Industrial Interchange	1/2"
	AMFLO	C10
	Hansen	520
	Foster	5205
	1/2"	Parker 17
	11 mm	
	1/2"	



ISO 6150-C-17

SERIES G

DN	TST	107.11
	TST	SV - DN 11
	11 mm	
	1/2"	



ISO 6150-C-27

SERIES I

DN	TST	107.19
	TST	SV - DN 19
	19 mm	
	3/4"	

Choice of Couplings and Seals

Simple and quick connection with no force or loss of pressure in the system

Throughput media	Coupling		Seal		
	SC	SV 'R'	NBR	FPM	EPDM
Acetone	+				+
Acetylene	+		+		
Air	+		+		
Aircraft fuel JP3-6	+		+		
Ammonium nitrate		+			+
Amyl alcohol		+			+
Beer		+	+		
Blast furnace gas		+		+	
Borax		+		+	
Butane	+		+		
Butyl alcohol		+	+		
Butylene	+			+	
Caustic soda		+			+
Carbon disulphide		+		+	
Calcium hydroxide		+	+		
Citric acid		+	+		
Copper nitrate		+	+		
Coffee		+	+		
Compressed air	+		+		
Creosote		+	+		
Cresol		+		+	
Cyclohexane	+		+		
Diesel oil	+		+		
Distilled water		+	+		
Emulsion water-oil		+	+		
Essential oils	+			+	
Ethyl alcohol		+			+
Ethylene glycol	+		+		
Formalin		+	+		
Freon 13, 14, 32, 113	+		+		
Freon 114, 115, 142, 152	+		+		
Gear oil	+		+		
Glucose		+	+		

Throughput media	Coupling		Seal		
	SC	SV 'R'	NBR	FPM	EPDM
Glycerine	+		+		
Heating oil	+		+		
Helium	+		+		
Heptane	+		+		
Hydrogen	+		+		
Hydraulic mineral oil	+		+		
Ink		+	+		
Isopropyl alcohol	+			+	
Kerosene	+		+		
Linseed oil	+		+		
Liquid ammonia		+			+
Lubricating oil	+		+		
Magnesium hydroxide		+		+	
Machine oil	+		+		
Methane	+			+	
Methanol	+		+		
Milk		+	+		
Mineral oil	+		+		
Mercury	+		+		
Naphthalene	+			+	
Natural gas	+		+		
Nitrogen gas	+		+		
Oxalic acid		+		+	
Paraffin	+			+	
Petrol	+		+		
Petroleum	+		+		
Potassium hydroxide		+			+
Potassium sulphate		+	+		
Prussic acid		+		+	
Propane gas	+		+		
Phosphoric acid 10%		+		+	

Throughput media	Coupling		Seal		
	SC	SV 'R'	NBR	FPM	EPDM
Salicylic acid		+		+	
Sea water		+	+		
Sodium acetate		+			+
Sodium bicarbonate		+	+		
Sodium carbonate		+	+		
Sodium chloride		+	+		
Sodium sulphide		+	+		
Steam up to 200°		+			+
Sulphur dioxide		+			+
Sugar root juice		+	+		
Tar	+			+	
Tetrachloromethane		+		+	
Titanium tetrachloride		+		+	
Toluene		+		+	
Transformer oil		+	+		
Trichloroethylene		+		+	
Turpentine		+	+		
Turbo oil		+	+		
Vacuum	+		+		
Vegetable oils		+	+		
Water up to 80°		+	+		
Water up to 140°		+			+
Wine		+	+		
Whisky		+	+		
Xylol		+		+	
Zeolite		+	+		
Zinc acetate		+			+
Zinc chloride		+	+		

Choice of couplings and seals according to throughput media

This information is not binding and is based on the recommendations as made by the manufacturers of the seals.

The abbreviations mean:

- SC = Couplings SC
- SV 'R' = Couplings SV stainless steel
- NBR = Nitrile elastomer
- FPM = Fluorine elastomer
- EPDM = Ethylene-propylene elastomer



Excellent Seal

Even small leaks can lead to big losses and they can also cause serious accidents.

It has been shown that in the case of compressed air, leaking couplings account for an energy loss of 8-15%.

Air Consumption of Pneumatic Hand Tools

Applications for TST Couplings Series A1, B1, K, P, N DN6 / 1/4" Series C, D, E, E1, M, J DN8 / 3/8"

Flow rate at 68°F (20°C) and 87 psi (6 bar)

Débit par 20°C (68°F) / 87 psi (6 bar)

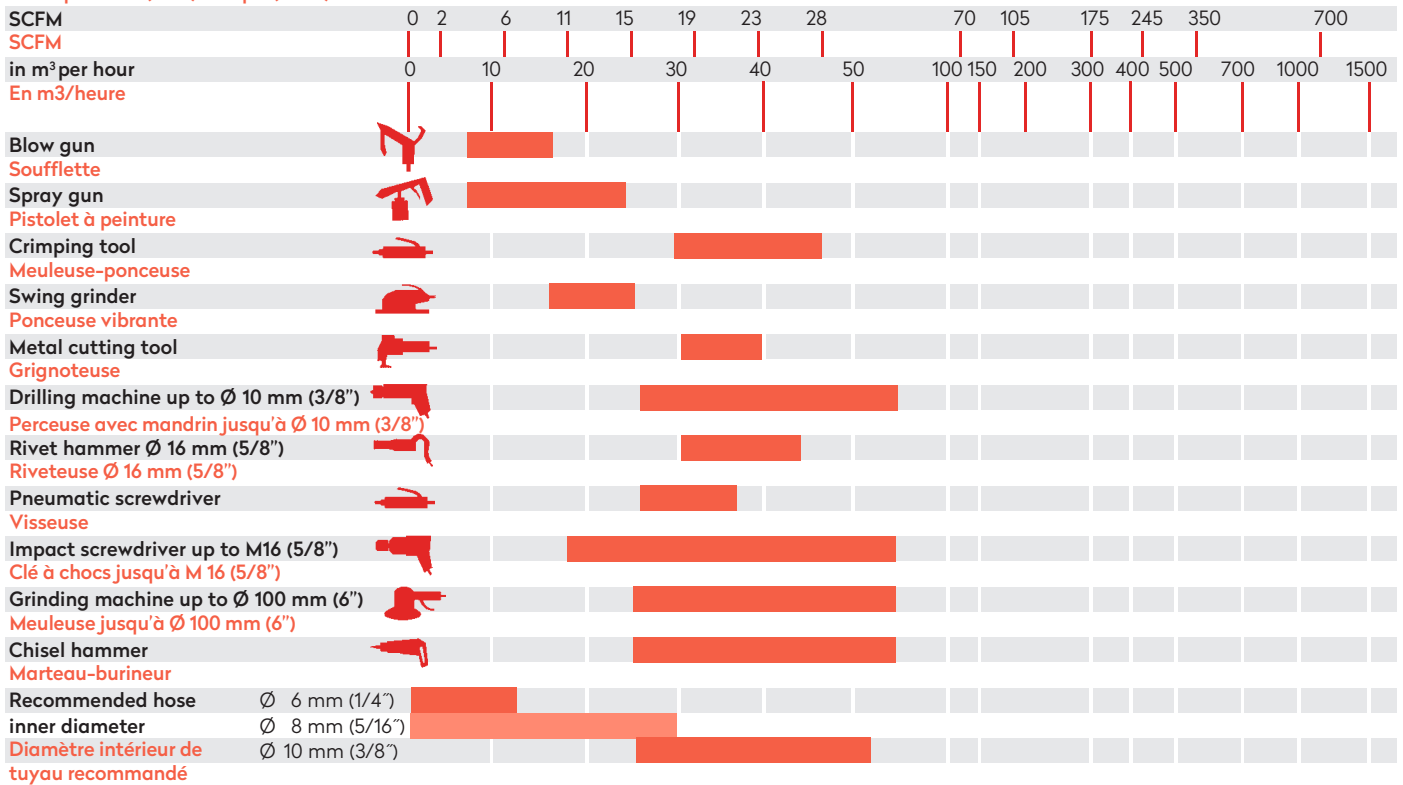

Applications for TST Couplings Series G, H, HB DN11 / 1/2" Serie I DN19 / 3/4"

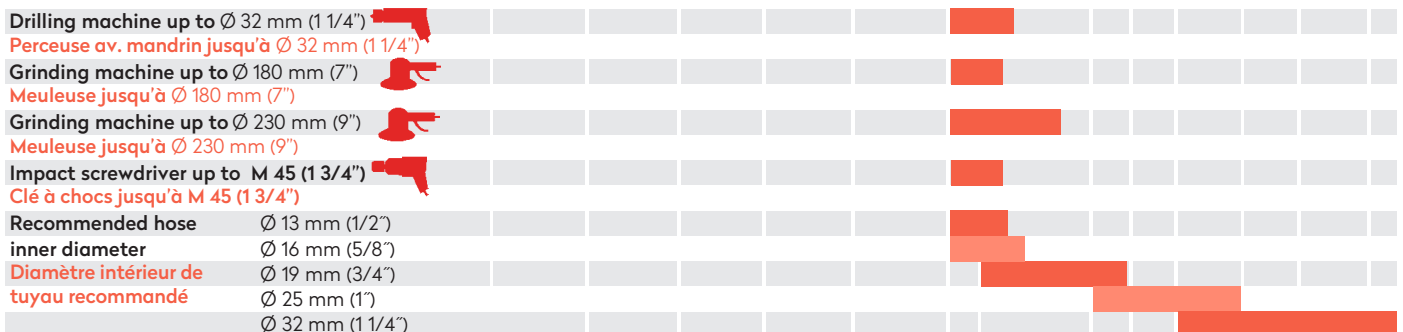

SC Series A1

DN6

1/4"

NEW!



ISO 4414 EN 983



EN

Features

- Full flow, negligible loss of pressure
- Simple operation, no force required
- Compact design

DE

Auf einen Blick

- Voller Durchgang, geringer Druckverlust
- Einfache Bedienung ohne Kraftaufwand
- Kompakte Bauform

FR

En bref

- Passage intégral, faible perte de pression
- Maniement simple et sans efforts
- Construction compacte

NL

In een oogopslag

- Volledige doorlaat, weinig drukverlies
- Eenvoudige bediening zonder krachtsinspanning
- Compact ontwerp

Operating Pressure	Betriebsdruck	Pression de service	Werkdruk
<ul style="list-style-type: none"> • Up to 25 bar, Vacuum till 100 mbar • connection/disconnection to max. 15 bar 	<ul style="list-style-type: none"> • Bis 25 bar, techn. Vakuum bis 100 mbar • ein-/auskuppeln bis max. 15 bar 	<ul style="list-style-type: none"> • Jusqu'à 25 bar, Vide technique jusqu'à 100 mbar • accouplement/désaccouplement jusqu'à 15 bar max 	<ul style="list-style-type: none"> • tot 25 bar, 100 mbar Vacuum • aan- en afkoppelen tot max. 15 bar

<p>-20° to +100°C (NBR) -4° to +212°F</p>	<p>295 00 233</p>	<p>295 00 003</p>
---	-------------------	-------------------

Materials, Seals	Material Code	Optional
	<p>A = Steel, nickel plated (for thread) aluminum (for hose tail) B = Steel, tenifer treated C = Stainless steel E = Nitrile elastomer (NBR) I = Surface hardened steel, nickel plated S = Surface hardened steel, galvanized Z = Zinc diecast, nickel plated, orange rubber coating</p>	<div style="display: flex; align-items: center;"> <div style="border: 1px solid gray; padding: 5px;">295 00 385</div> </div> <div style="display: flex; align-items: center; margin-top: 10px;"> <div style="border: 1px solid gray; padding: 5px;">295 00 480</div> </div>

Options	Plug Profile A1	Compatible with														
<div style="display: flex; justify-content: space-around; align-items: center;"> <div style="border: 1px solid red; padding: 5px; background-color: red; color: white;">FPM</div> <div style="border: 1px solid red; padding: 5px; background-color: red; color: white;">EPDM</div> <div style="border: 1px solid red; padding: 5px; background-color: red; color: white;">Swivel NEW</div> <div style="border: 1px solid red; padding: 5px; background-color: red; color: white;">AISI303 NEW <small>Stainless Steel</small></div> </div>	<p style="color: red; font-weight: bold;">S = Surface hardened steel, galvanized</p>	<table border="0"> <tr><td>TST</td><td>014, 022</td></tr> <tr><td>AMFLO</td><td>C38</td></tr> <tr><td>ARO</td><td>210</td></tr> <tr><td>Cejn</td><td>300</td></tr> <tr><td>Foster</td><td>210</td></tr> <tr><td>Parker</td><td>B53</td></tr> <tr><td>Rectus</td><td>14,22</td></tr> </table>	TST	014, 022	AMFLO	C38	ARO	210	Cejn	300	Foster	210	Parker	B53	Rectus	14,22
TST	014, 022															
AMFLO	C38															
ARO	210															
Cejn	300															
Foster	210															
Parker	B53															
Rectus	14,22															



tst®

SC Series A1

DN6
1/4"



SWING COUPLING SCHWENKKUPPLUNG

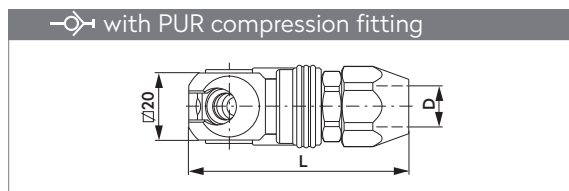
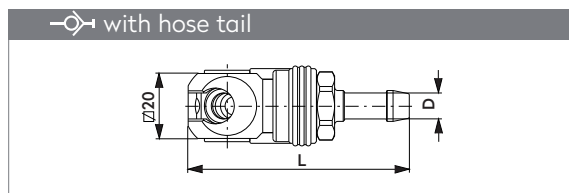
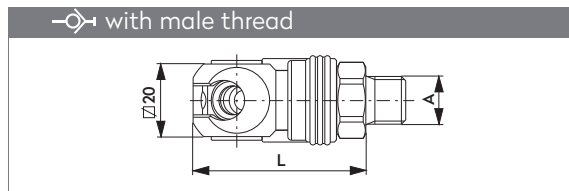
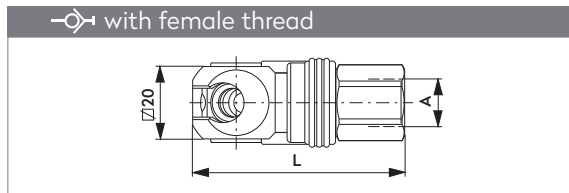

A	Part No.	L	L (swivel)
G1/4	205 00 287	56.1	65.6
G3/8	205 00 288	57.6	67.1
G1/2	205 00 289	61.1	70.6
NPT1/4	205 00 291	56.1	65.6
NPT3/8	205 00 292	58.6	68.1
NPT1/2	205 00 293	64.6	74.1

A	Part No.	L	L (swivel)
G1/4	205 00 294	47.6	56.6
G3/8	205 00 295	47.6	56.6
G1/2	205 00 296	48.6	57.6
NPT1/4	205 00 297	48.8	57.8
NPT3/8	205 00 298	48.8	57.8
NPT1/2	205 00 299	48.6	57.6

D	Part No.	L	L (swivel)
6 mm 1/4"	205 00 300	68.1	77.1
8 mm 5/16"	205 00 301	68.1	77.1
10 mm 3/8"	205 00 302	68.1	77.1

D	Part No.	L
6.5 X 10	205 00 304	62.6
8 X 12	205 00 305	65.6

PLUG STECKNIPPEL

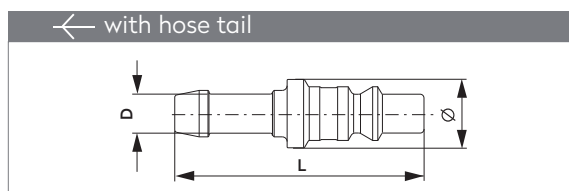
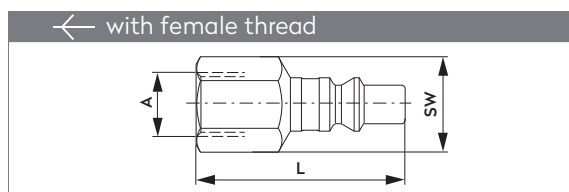
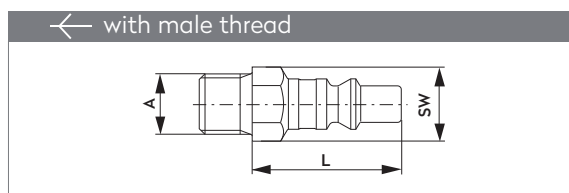

A	Part No.	L	SW
G1/8	255 00 000	34.0	14
G1/4	255 00 001	31.0	14
NPT1/4	255 00 003	30.7	14
NPT3/8	255 00 066	32.7	19

A	Part No.	L	SW
G1/4	255 00 005	43.0	17
NPT1/4	255 00 007	43.0	17
NPT1/8	255 00 068	45.0	19

D	Part No.	L	∅
6 mm 1/4"	255 00 008	51.0	14
8 mm 5/16"	255 00 009	51.0	14
10 mm 3/8"	255 00 010	51.0	14

SC Series B1

DN6

1/4"

NEW!



- ISO 4414 EN 983
- US: MIL-C-4109
- ISO 6150-B-12
- AFNOR: B-12 NF E 49-053



EN

Features

- Full flow, negligible loss of pressure
- Simple operation, no force required
- Compact design

DE

Auf einen Blick

- Voller Durchgang, geringer Druckverlust
- Einfache Bedienung ohne Kraftaufwand
- Kompakte Bauform

FR

En bref

- Passage intégral, faible perte de pression
- Maniement simple et sans efforts
- Construction compacte

NL

In een oogopslag

- Volledige doorlaat, weinig drukverlies
- Eenvoudige bediening zonder krachtsinspanning
- Compact ontwerp

Operating Pressure	Betriebsdruck	Pression de service	Werkdruk
<ul style="list-style-type: none"> • Up to 25 bar, Vacuum till 100 mbar • connection/disconnection to max. 15 bar 	<ul style="list-style-type: none"> • Bis 25 bar, techn. Vakuum bis 100 mbar • ein-/auskuppeln bis max. 15 bar 	<ul style="list-style-type: none"> • Jusqu'à 25 bar, Vide technique jusqu'à 100 mbar • accouplement/désaccouplement jusqu'à 15 bar max 	<ul style="list-style-type: none"> • tot 25 bar, 100 mbar Vacuum • aan- en afkoppelen tot max. 15 bar

<p>-20° to +100°C (NBR) -4° to +212°F</p>	<p>295 00 233</p>	<p>295 00 003</p>
---	-------------------	-------------------

Materials, Seals	Material Code	Optional
	<p>A = Steel, nickel plated (for thread) aluminum (for hose tail)</p> <p>B = Steel, tenifer treated</p> <p>C = Stainless steel</p> <p>E = Nitrile elastomer (NBR)</p> <p>I = Surface hardened steel, nickel plated</p> <p>S = Surface hardened steel, galvanized</p> <p>Z = Zinc diecast, nickel plated, orange rubber coating</p>	<div style="display: flex; align-items: center;"> <div style="margin-left: 20px;">295 00 385</div> </div> <div style="display: flex; align-items: center; margin-top: 10px;"> <div style="margin-left: 20px;">295 00 480</div> </div>

Options	Plug Profile B1	Compatible with														
<div style="display: flex; justify-content: space-around; align-items: center;"> <div style="border: 1px solid red; padding: 5px; background-color: red; color: white;">FPM</div> <div style="border: 1px solid red; padding: 5px; background-color: red; color: white;">EPDM</div> <div style="border: 1px solid red; padding: 5px; background-color: red; color: white;">Swivel NEW</div> <div style="border: 1px solid red; padding: 5px; background-color: red; color: white;">AISI303 NEW <small>Stainless Steel</small></div> </div>	<p>S = Surface hardened steel, galvanized</p>	<table border="0"> <tr><td>TST</td><td>023, 024</td></tr> <tr><td>Industrial Interchange</td><td>1/4"</td></tr> <tr><td>AMFLO</td><td>C20B</td></tr> <tr><td>Hansen</td><td>1000</td></tr> <tr><td>Foster</td><td>3003</td></tr> <tr><td>Parker</td><td>B23</td></tr> <tr><td>Cejn</td><td>310</td></tr> </table>	TST	023, 024	Industrial Interchange	1/4"	AMFLO	C20B	Hansen	1000	Foster	3003	Parker	B23	Cejn	310
TST	023, 024															
Industrial Interchange	1/4"															
AMFLO	C20B															
Hansen	1000															
Foster	3003															
Parker	B23															
Cejn	310															

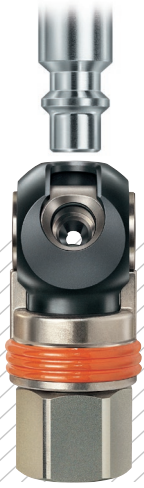

tst®

SC Series B1

DN6
1/4"



SWING COUPLING SCHWENKKUPPLUNG

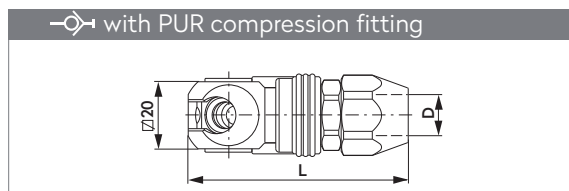
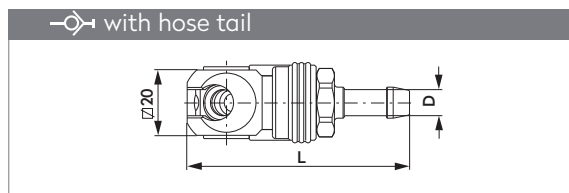
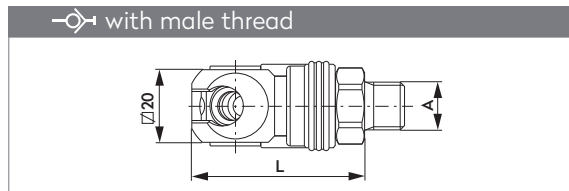
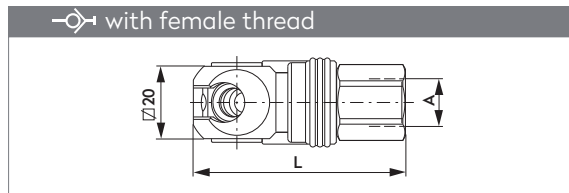

A	Part No.	L	L (swivel)
G1/4	205 00 307	56.1	65.6
G3/8	205 00 308	57.6	67.1
G1/2	205 00 309	61.1	70.6
NPT1/4	205 00 311	56.1	65.6
NPT3/8	205 00 312	58.6	68.1
NPT1/2	205 00 313	64.6	74.1

A	Part No.	L	L (swivel)
G1/4	205 00 314	47.6	56.6
G3/8	205 00 315	47.6	56.6
G1/2	205 00 316	48.6	57.6
NPT1/4	205 00 317	48.8	57.8
NPT3/8	205 00 318	48.8	57.8
NPT1/2	205 00 319	48.6	57.6

D	Part No.	L	L (swivel)
6 mm 1/4"	205 00 320	68.1	77.1
8 mm 5/16"	205 00 321	68.1	77.1
10 mm 3/8"	205 00 322	68.1	77.1

D	Part No.	L
6.5 X 10	205 00 324	62.6
8 X 12	205 00 325	65.6

PLUG STECKNIPPEL

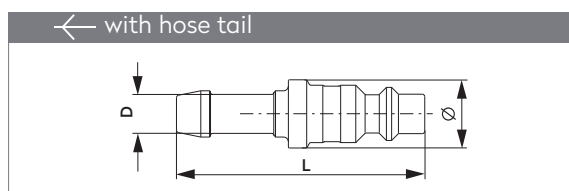
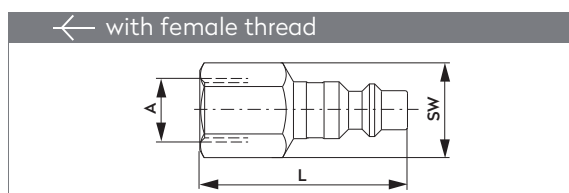
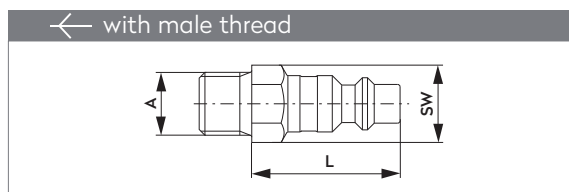

A	Part No.	L	SW
G1/8	255 00 011	34.0	14
G1/4	255 00 012	31.0	14
NPT1/4	255 00 014	30.7	14
NPT3/8	255 00 069	32.7	19

A	Part No.	L	SW
G1/4	255 00 016	43.0	17
NPT1/4	255 00 018	43.0	17
NPT3/8	255 00 274	45.0	19

D	Part No.	L	Ø
6 mm 1/4"	255 00 019	51.0	14
8 mm 5/16"	255 00 020	51.0	14
10 mm 3/8"	255 00 021	51.0	14

NEW!



- ISO 4414 EN 983
- ISO 6150-C-10
- AFNOR: C-10 NF E 49-053



EN

Features

- Full flow, negligible loss of pressure
- Simple operation, no force required
- Compact design

DE

Auf einen Blick

- Voller Durchgang, geringer Druckverlust
- Einfache Bedienung ohne Kraftaufwand
- Kompakte Bauform

FR

En bref

- Passage intégral, faible perte de pression
- Maniement simple et sans efforts
- Construction compacte

NL

In een oogopslag

- Volledige doorlaat, weinig drukverlies
- Eenvoudige bediening zonder krachtsinspanning
- Compact ontwerp

Operating Pressure	Betriebsdruck	Pression de service	Werkdruk
<ul style="list-style-type: none"> • Up to 25 bar, Vacuum till 100 mbar • connection/disconnection to max. 15 bar 	<ul style="list-style-type: none"> • Bis 25 bar, techn. Vakuum bis 100 mbar • ein-/auskuppeln bis max. 15 bar 	<ul style="list-style-type: none"> • Jusqu'à 25 bar, Vide technique jusqu'à 100 mbar • accouplement/désaccouplement jusqu'à 15 bar max 	<ul style="list-style-type: none"> • tot 25 bar, 100 mbar Vacuüm • aan- en afkoppelen tot max. 15 bar

<p>-20° to + 100°C (NBR) -4° to + 212°F</p>	<p>295 00 233</p>	<p>295 00 003</p>
---	-------------------	-------------------

Materials, Seals	Material Code	Optional
	<p>A = Steel, nickel plated (for thread) aluminum (for hose tail)</p> <p>B = Steel, tenifer treated</p> <p>C = Stainless steel</p> <p>E = Nitrile elastomer (NBR)</p> <p>I = Surface hardened steel, nickel plated</p> <p>S = Steel, tenifer treated</p> <p>Z = Zinc diecast, nickel plated, orange rubber coating</p>	<div style="display: flex; align-items: center;"> <div> <p>295 00 385</p> </div> </div> <div style="display: flex; align-items: center; margin-top: 10px;"> <div> <p>295 00 480</p> </div> </div>

Options	Plug Profile K	Compatible with										
<div style="display: flex; justify-content: space-around; align-items: center;"> <div style="border: 1px solid black; padding: 5px; background-color: red; color: white;">FPM</div> <div style="border: 1px solid black; padding: 5px; background-color: red; color: white;">EPDM</div> <div style="border: 1px solid black; padding: 5px; background-color: red; color: white;">Swivel NEW</div> <div style="border: 1px solid black; padding: 5px; background-color: red; color: white;">AISI303 NEW <small>Stainless Steel</small></div> </div>	<p style="text-align: center;">S = Steel, tenifer treated</p>	<table style="width: 100%; border-collapse: collapse;"> <tr> <td>TST</td> <td style="text-align: right;">107.06</td> </tr> <tr> <td>TST</td> <td style="text-align: right;">018</td> </tr> <tr> <td>TST</td> <td style="text-align: right;">SV - DN 6</td> </tr> <tr> <td>Rectus</td> <td style="text-align: right;">18</td> </tr> <tr> <td>Cejn</td> <td style="text-align: right;">291</td> </tr> </table>	TST	107.06	TST	018	TST	SV - DN 6	Rectus	18	Cejn	291
TST	107.06											
TST	018											
TST	SV - DN 6											
Rectus	18											
Cejn	291											

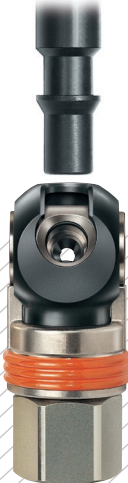

tst®

SC Series K

DN6
1/4"



SWING COUPLING SCHWENKKUPPLUNG

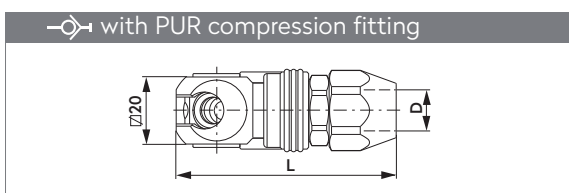
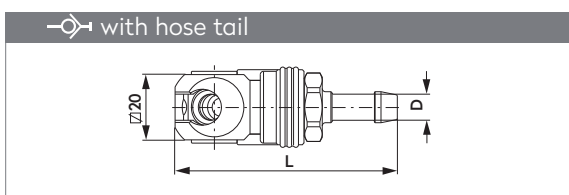
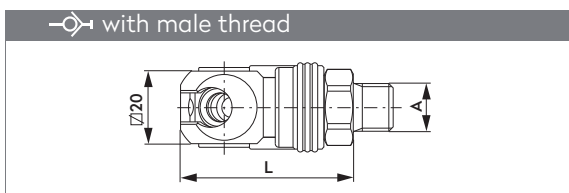
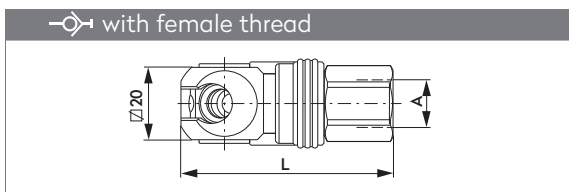

A	Part No.	L	L (swivel)
G1/4	205 00 156	56.1	65.6
G3/8	205 00 157	57.6	67.1
G1/2	205 00 158	61.1	70.6
NPT1/4	205 00 160	56.1	65.6
NPT3/8	205 00 161	58.6	68.1
NPT1/2	205 00 162	64.6	74.1

A	Part No.	L	L (swivel)
G1/4	205 00 163	47.6	56.6
G3/8	205 00 164	47.6	56.6
G1/2	205 00 165	48.6	57.6
NPT1/4	205 00 166	48.8	57.8
NPT3/8	205 00 167	48.8	57.8
NPT1/2	205 00 168	48.6	57.6

D	Part No.	L	L (swivel)
6 mm 1/4"	205 00 169	68.1	77.1
8 mm 5/16"	205 00 170	68.1	77.1
10 mm 3/8"	205 00 171	68.1	77.1

D	Part No.	L
6.5 X 10	205 00 276	62.6
8 X 12	205 00 277	65.6

PLUG STECKNIPPEL

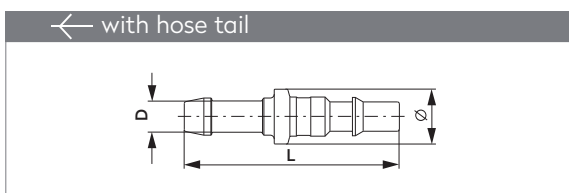
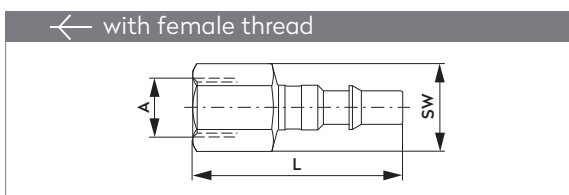
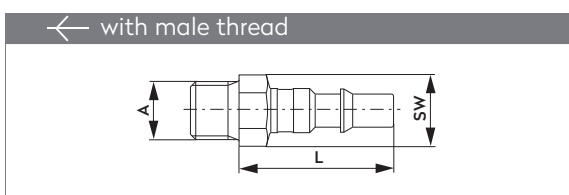

A	Part No.	L	SW
G1/8	255 00 093	38.0	14
G1/4	255 00 091	35.0	14
G3/8	255 00 092	38.0	17
NPT1/4	255 00 112	35.7	14
NPT3/8	255 00 117	38.7	17

A	Part No.	L	SW
G1/8	255 00 100	46.0	14
G1/4	255 00 088	47.0	17
NPT1/4	255 00 119	48.0	17

D	Part No.	L	Ø
6 mm 1/4"	255 00 113	55.0	14
8 mm 5/16"	255 00 114	55.0	14
10 mm 3/8"	255 00 115	55.0	14
13 mm 1/2"	255 00 116	55.0	16

NEW!



ISO 4414 EN 983

Spanish Profile



EN

Features

- Full flow, negligible loss of pressure
- Simple operation, no force required
- Compact design

DE

Auf einen Blick

- Voller Durchgang, geringer Druckverlust
- Einfache Bedienung ohne Kraftaufwand
- Kompakte Bauform

FR

En bref

- Passage intégral, faible perte de pression
- Maniement simple et sans efforts
- Construction compacte

NL

In een oogopslag

- Volledige doorlaat, weinig drukverlies
- Eenvoudige bediening zonder krachtsinspanning
- Compact ontwerp



Operating Pressure

- Up to 25 bar, Vacuum till 100 mbar
- connection/disconnection to max. 15 bar



Betriebsdruck

- Bis 25 bar, techn. Vakuum bis 100 mbar
- ein-/auskuppeln bis max. 15 bar



Pression de service

- Jusqu'à 25 bar, Vide technique jusqu'à 100 mbar
- accouplement/désaccouplement jusqu'à 15 bar max



Werkdruk

- tot 25 bar, 100 mbar Vacuüm
- aan- en afkoppelen tot max. 15 bar



-20° to + 100°C (NBR)
-4° to + 212°F



295 00 233



295 00 003

Materials, Seals

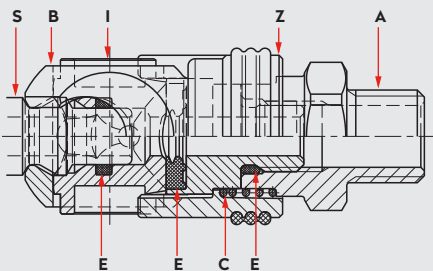

Material Code

- A = Steel, nickel plated (for thread) aluminum (for hose tail)
- B = Steel, tenifer treated
- C = Stainless steel
- E = Nitrile elastomer (NBR)
- I = Surface hardened steel, nickel plated
- S = Surface hardened steel, galvanized
- Z = Zinc diecast, nickel plated, orange rubber coating

Optional



295 00 385



295 00 480

Options



Compatible with

Imopac CD25, -S, -N

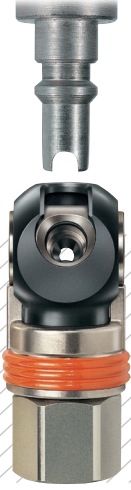

tst®

SC Series N

DN6
1/4"



SWING COUPLING SCHWENKKUPPLUNG

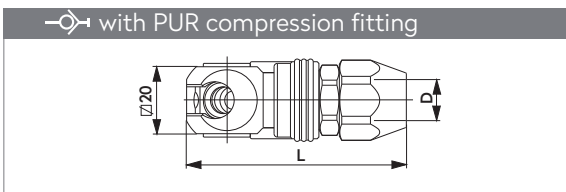
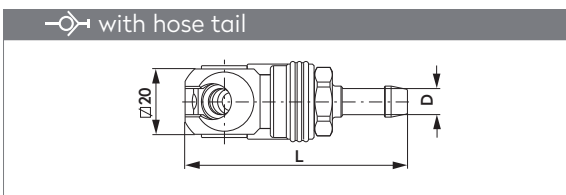
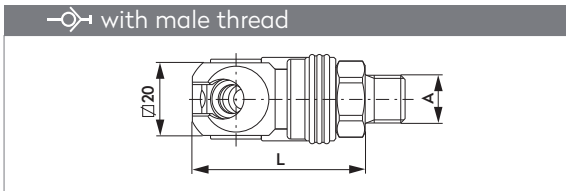
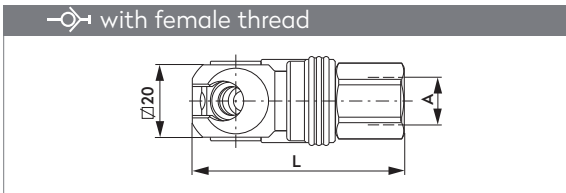

A	Part No.	L	L (swivel)
G1/4	205 00 726	56.1	65.6
G3/8	205 00 727	57.6	67.1
G1/2	205 00 728	61.1	70.6

A	Part No.	L	L (swivel)
G1/4	205 00 729	47.6	56.6
G3/8	205 00 730	47.6	56.6
G1/2	205 00 731	48.6	57.6

D	Part No.	L	L (swivel)
6 mm 1/4"	205 00 732	68.1	77.1
8 mm 5/16"	205 00 733	68.1	77.1
10 mm 3/8"	205 00 734	68.1	77.1

D	Part No.	L
6.5 X 10	205 00 735	62.6
8 X 12	205 00 736	65.6

NEW!



ISO 4414 EN 983

British Profile



EN

Features

- Full flow, negligible loss of pressure
- Simple operation, no force required
- Compact design

DE

Auf einen Blick

- Voller Durchgang, geringer Druckverlust
- Einfache Bedienung ohne Kraftaufwand
- Kompakte Bauform

FR

En bref

- Passage intégral, faible perte de pression
- Maniement simple et sans efforts
- Construction compacte

NL

In een oogopslag

- Volledige doorlaat, weinig drukverlies
- Eenvoudige bediening zonder krachtsinspanning
- Compact ontwerp

Operating Pressure	Betriebsdruck	Pression de service	Werkdruk
<ul style="list-style-type: none"> • Up to 25 bar, Vacuum till 100 mbar • connection/disconnection to max. 15 bar 	<ul style="list-style-type: none"> • Bis 25 bar, techn. Vakuum bis 100 mbar • ein-/auskuppeln bis max. 15 bar 	<ul style="list-style-type: none"> • Jusqu'à 25 bar, Vide technique jusqu'à 100 mbar • accouplement/désaccouplement jusqu'à 15 bar max 	<ul style="list-style-type: none"> • tot 25 bar, 100 mbar Vacuum • aan- en afkoppelen tot max. 15 bar

<p>-20° to +100°C (NBR) -4° to +212°F</p>	<p>295 00 233</p>	<p>295 00 003</p>
---	-------------------	-------------------

Materials, Seals

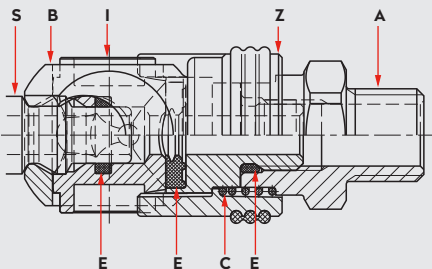

Material Code

- A = Steel, nickel plated (for thread) aluminum (for hose tail)
- B = Steel, tenifer treated
- C = Stainless steel
- E = Nitrile elastomer (NBR)
- I = Surface hardened steel, nickel plated
- S = Surface hardened steel, galvanized
- Z = Zinc diecast, nickel plated, orange rubber coating

Optional

	295 00 385
	295 00 480

Options



Plug Profile P

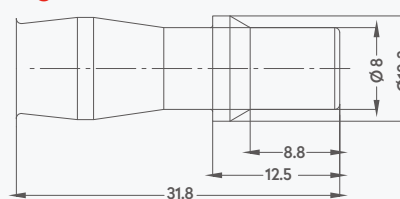

S = Surface hardened steel, galvanized

Compatible with

TST 019
PCL AC21, AC29, AC91



SWING COUPLING SCHWENKKUPPLUNG

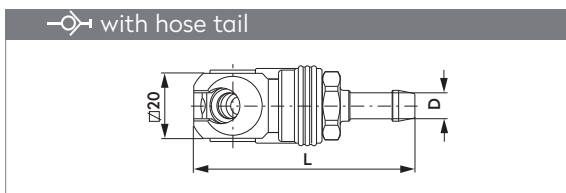
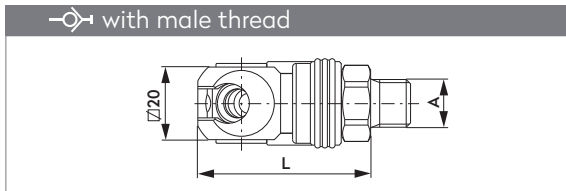
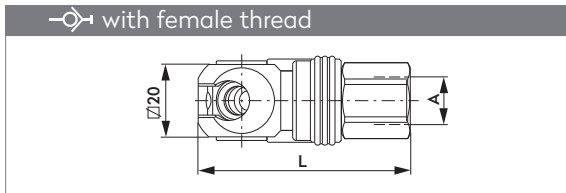

A	Part No.	L	L (swivel)
G1/4	205 00 438	56.1	65.6
G3/8	205 00 439	57.6	67.1
G1/2	205 00 440	61.1	70.6

A	Part No.	L	L (swivel)
G1/4	205 00 434	47.6	56.6
G3/8	205 00 441	47.6	56.6
G1/2	205 00 442	48.6	57.6

A	Part No.	L	L (swivel)
6 mm 1/4"	205 00 443	68.1	77.1
8 mm 5/16"	205 00 444	68.1	77.1
10 mm 3/8"	205 00 445	68.1	77.1

PLUG STECKNIPPEL

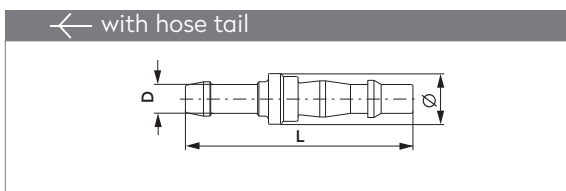
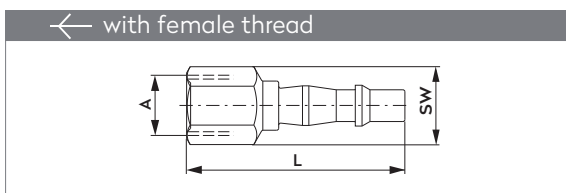
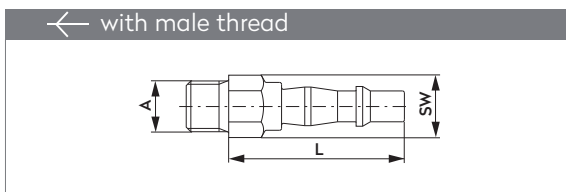

A	Part No.	L	SW
G1/4	255 00 320	43.0	14
G3/8	255 00 321	45.5	17

A	Part No.	L	SW
G1/4	255 00 318	55.0	17
G3/8	255 00 319	57.5	19

D	Part No.	L	Ø
6 mm 1/4"	255 00 322	63.0	14
8 mm 5/16"	255 00 323	63.0	14
10 mm 3/8"	255 00 324	63.0	14

NEW!



ISO 4414 EN 983

European Profile



EN

Features

- Full flow, negligible loss of pressure
- Simple operation, no force required
- Compact design

DE

Auf einen Blick

- Voller Durchgang, geringer Druckverlust
- Einfache Bedienung ohne Kraftaufwand
- Kompakte Bauform

FR

En bref

- Passage intégral, faible perte de pression
- Maniement simple et sans efforts
- Construction compacte

NL

In een oogopslag

- Volledige doorlaat, weinig drukverlies
- Eenvoudige bediening zonder krachtsinspanning
- Compact ontwerp

Operating Pressure	Betriebsdruck	Pression de service	Werkdruk
<ul style="list-style-type: none"> • Up to 25 bar, Vacuum till 100 mbar • connection/disconnection to max. 15 bar 	<ul style="list-style-type: none"> • Bis 25 bar, techn. Vakuum bis 100 mbar • ein-/auskuppeln bis max. 15 bar 	<ul style="list-style-type: none"> • Jusqu'à 25 bar, Vide technique jusqu'à 100 mbar • accouplement/désaccouplement jusqu'à 15 bar max 	<ul style="list-style-type: none"> • tot 25 bar, 100 mbar Vacuum • aan- en afkoppelen tot max. 15 bar

<p>-20° to +100°C (NBR) -4° to +212°F</p>	<p>5003487</p>	<p>295 00 515</p>
---	----------------	-------------------

Materials, Seals	Material Code	Optional
	<p>A = Steel, nickel plated (for thread) aluminum (for hose tail) B = Steel, tenifer treated C = Stainless steel E = Nitrile elastomer (NBR) I = Surface hardened steel, nickel plated S = Surface hardened steel, galvanized Z = Zinc diecast, nickel plated, orange rubber coating</p>	<div style="display: flex; flex-direction: column;"> <div style="display: flex; align-items: center;"> <div style="margin-left: 20px;">295 00 340</div> </div> <div style="display: flex; align-items: center; margin-top: 10px;"> <div style="margin-left: 20px;">295 00 481</div> </div> </div>

Options	Plug Profile C	Compatible with						
<div style="display: flex; justify-content: space-around;"> <div style="border: 1px solid black; padding: 5px; background-color: red; color: white;">FPM</div> <div style="border: 1px solid black; padding: 5px; background-color: red; color: white;">EPDM</div> <div style="border: 1px solid black; padding: 5px; background-color: red; color: white;">Swivel NEW</div> <div style="border: 1px solid black; padding: 5px; background-color: red; color: white;">AISI303 NEW <small>Stainless Steel</small></div> </div>	<p>Ø10, 11.95, 5.8, 10, 21.8</p> <p>S = Surface hardened steel, galvanized</p>	<table border="0"> <tr> <td>TST</td> <td>025, 026</td> </tr> <tr> <td>Cejn</td> <td>320</td> </tr> <tr> <td>Rectus</td> <td>25, 26</td> </tr> </table>	TST	025, 026	Cejn	320	Rectus	25, 26
TST	025, 026							
Cejn	320							
Rectus	25, 26							



tst®

SC Series C

DN8
3/8"



SWING COUPLING SCHWENKKUPPLUNG

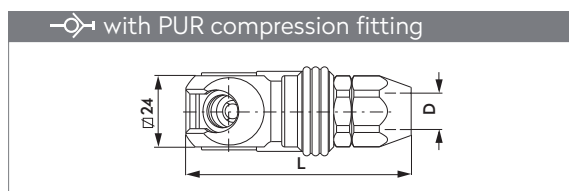
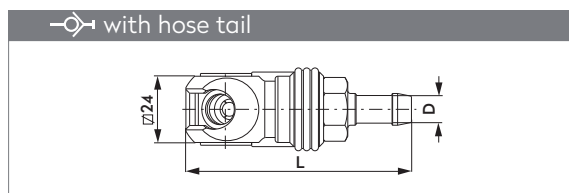
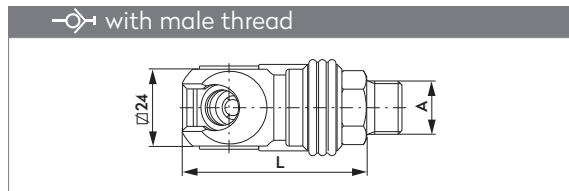
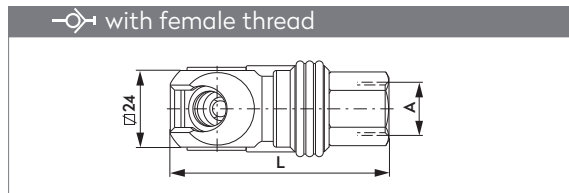

A	Part No.	L	L (swivel)
G1/4	205 00 345	68.5	74.5
G3/8	205 00 346	68.5	74.5
G1/2	205 00 347	69.5	75.5
NPT1/4	205 00 348	68.5	74.5
NPT3/8	205 00 349	68.5	74.5
NPT1/2	205 00 350	73.5	79.5

A	Part No.	L	L (swivel)
G1/4	205 00 351	57.5	63.5
G3/8	205 00 352	57.5	63.5
G1/2	205 00 353	58.5	64.5
NPT1/4	205 00 375	56.2	62.2
NPT3/8	205 00 374	56.2	62.2
NPT1/2	205 00 355	58.5	64.5

D	Part No.	L	L (swivel)
8 mm 5/16"	205 00 356	81.5	87.5
10 mm 3/8"	205 00 357	81.5	87.5
13 mm 1/2"	205 00 358	81.5	87.5

D	Part No.	L
8 X 12	205 00 360	75.8
11 X 16	205 00 361	80.8

PLUG STECKNIPPEL

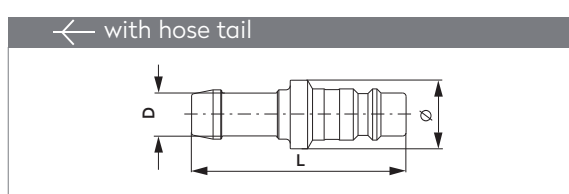
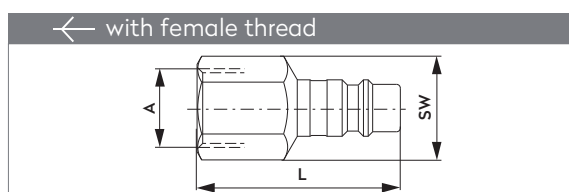
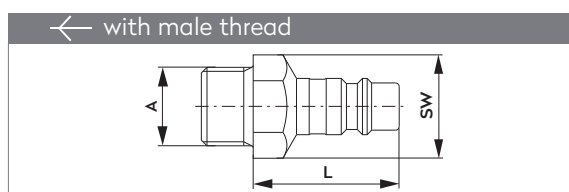

A	Part No.	L	SW
G1/4	255 00 023	31.0	14
G3/8	255 00 024	31.0	19
NPT1/4	255 00 275	28.7	14
NPT3/8	255 00 177	28.7	19

A	Part No.	L	SW
G1/4	255 00 026	42.0	17
G3/8	255 00 027	43.0	19
NPT1/4	255 00 276	42.0	17
NPT3/8	255 00 178	43.0	19

D	Part No.	L	\varnothing
8 mm 5/16"	255 00 029	50.0	14
10 mm 3/8"	255 00 030	50.0	14
13 mm 1/2"	255 00 031	50.0	16

NEW!



ISO 4414

EN 983

Japanese Profile



EN

Features

- Full flow, negligible loss of pressure
- Simple operation, no force required
- Compact design

DE

Auf einen Blick

- Voller Durchgang, geringer Druckverlust
- Einfache Bedienung ohne Kraftaufwand
- Kompakte Bauform

FR

En bref

- Passage intégral, faible perte de pression
- Maniement simple et sans efforts
- Construction compacte

NL

In een oogopslag

- Volledige doorlaat, weinig drukverlies
- Eenvoudige bediening zonder krachtsinspanning
- Compact ontwerp

Operating Pressure	Betriebsdruck	Pression de service	Werkdruk
<ul style="list-style-type: none"> • Up to 25 bar, Vacuum till 100 mbar • connection/disconnection to max. 15 bar 	<ul style="list-style-type: none"> • Bis 25 bar, techn. Vakuum bis 100 mbar • ein-/auskuppeln bis max. 15 bar 	<ul style="list-style-type: none"> • Jusqu'à 25 bar, Vide technique jusqu'à 100 mbar • accouplement/désaccouplement jusqu'à 15 bar max 	<ul style="list-style-type: none"> • tot 25 bar, 100 mbar Vacuüm • aan- en afkoppelen tot max. 15 bar

<p>-20° to + 100°C (NBR) -4° to + 212°F</p>	<p>5001079</p>	<p>295 00 515</p>
---	----------------	-------------------

Materials, Seals

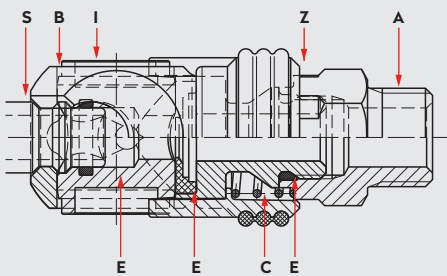

Material Code

- A = Steel, nickel plated (for thread) aluminum (for hose tail)
- B = Steel, tenifer treated
- C = Stainless steel
- E = Nitrile elastomer (NBR)
- I = Surface hardened steel, nickel plated
- S = Surface hardened steel, galvanized
- Z = Zinc diecast, nickel plated, orange rubber coating

Optional

	295 00 340
	295 00 481

Options



Plug Profile D

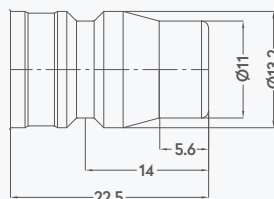

S = Surface hardened steel, galvanized

Compatible with

TST	013
Nitto	20, 30, 40
Cejn	315
Rectus	13



tst[®]

SC Series D

DN8
3/8"



SWING COUPLING SCHWENKUPPLUNG

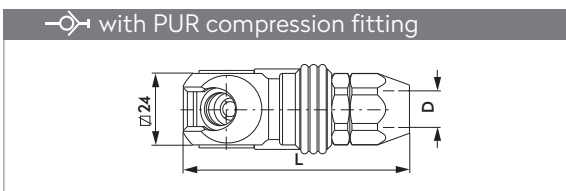
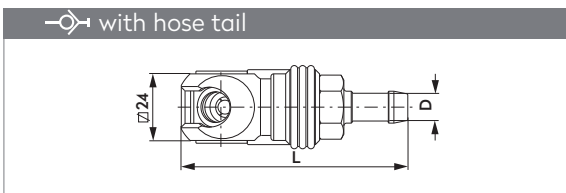
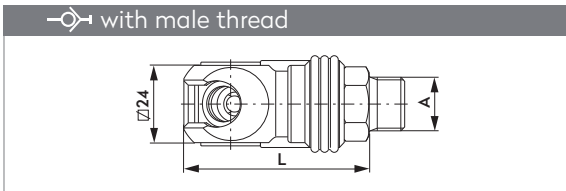
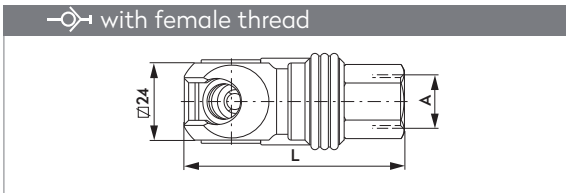

A	Part No.	L	L (swivel)
G1/4	205 00 018	68,5	74,5
G3/8	205 00 019	68,5	74,5
G1/2	205 00 020	69,5	75,5
NPT1/4	205 00 034	68,5	74,5
NPT3/8	205 00 035	68,5	74,5
NPT1/2	205 00 036	73,5	79,5

A	Part No.	L	L (swivel)
G1/4	205 00 053	57,5	63,5
G3/8	205 00 021	57,5	63,5
G1/2	205 00 022	58,5	64,5
NPT1/4	205 00 426	56,2	62,2
NPT3/8	205 00 037	56,2	62,2
NPT1/2	205 00 038	58,5	64,5

A	Part No.	L	L (swivel)
8 mm 5/16"	205 00 054	81,5	87,5
10 mm 3/8"	205 00 055	81,5	87,5
13 mm 1/2"	205 00 056	81,5	87,5

A	Part No.	L
6.5 X 10	205 00 057	72,8
8 X 12	205 00 058	75,8
11 X 16	205 00 059	80,8

PLUG STECKNIPPEL

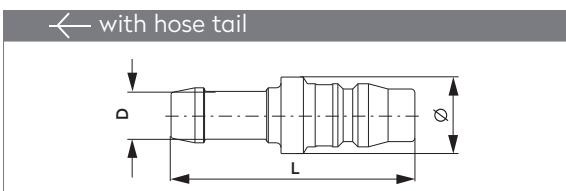
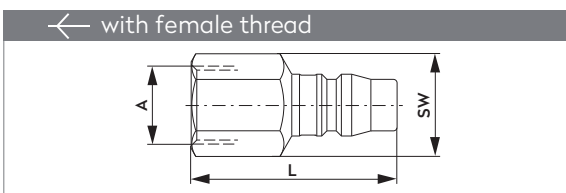
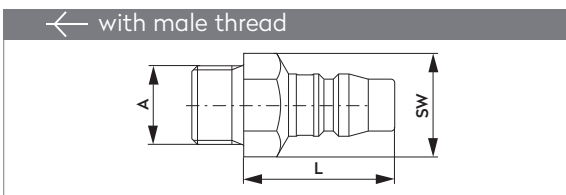

A	Part No.	L	SW
G1/4	255 00 032	32,0	14
G3/8	255 00 033	32,0	19
G1/2	255 00 034	32,0	24
NPT1/4	255 00 058	28,7	14
NPT3/8	255 00 059	28,7	19
NPT1/2	255 00 060	33,0	24

A	Part No.	L	SW
G1/4	255 00 035	43,0	17
G3/8	255 00 036	44,0	19
G1/2	255 00 037	48,5	27
NPT1/4	255 00 061	43,0	17
NPT3/8	255 00 062	44,0	19
NPT1/2	255 00 063	49,0	27

D	Part No.	L	\varnothing
8 mm 5/16"	255 00 038	51,0	14
10 mm 3/8"	255 00 039	51,0	14
13 mm 1/2"	255 00 040	51,0	16

SC Series DL

DN8

3/8"

NEW!



ISO 4414 EN 983

Japanese Profile



Not suitable for knocking, pulsating and vibrating compressed air tools

EN

Features

- Full flow, negligible loss of pressure
- Simple operation, no force required
- Compact design
- Light weight 75 g

DE

Auf einen Blick

- Voller Durchgang, geringer Druckverlust
- Einfache Bedienung ohne Kraftaufwand
- Kompakte Bauform
- Geringes Gewicht 75 g

FR

En bref

- Passage intégral, faible perte de pression
- Maniement simple et sans efforts
- Construction compacte
- Léger 75 g

NL

In een oogopslag

- Volledige doorlaat, weinig drukverlies
- Eenvoudige bediening, zonder krachtsinspanning
- Compact ontwerp
- Weegt weinig 75 g

Operating Pressure	Betriebsdruck	Pression de service	Werkdruk
<ul style="list-style-type: none"> • Up to 25 bar, Vacuum till 100 mbar • connection/disconnection to max. 15 bar 	<ul style="list-style-type: none"> • Bis 25 bar, techn. Vakuum bis 100 mbar • ein-/auskuppeln bis max. 15 bar 	<ul style="list-style-type: none"> • Jusqu'à 25 bar, Vide technique jusqu'à 100 mbar • accouplement/désaccouplement jusqu'à 15 bar max 	<ul style="list-style-type: none"> • tot 25 bar, 100 mbar Vacuüm • aan- en afkoppelen tot max. 15 bar

<p>-20° to +100°C (NBR) -4° to +212°F</p>	<p>5001079</p>	<p>295 00 515</p>
---	----------------	-------------------

Materials, Seals

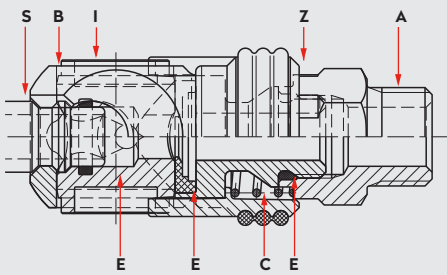

Material Code

- A = Aluminum
- B = Aluminum
- C = Stainless steel
- E = Nitrile elastomer (NBR)
- I = Aluminum
- S = Surface hardened steel, galvanized
- Z = Zinc diecast, nickel plated, orange rubber coating

Options



Plug Profile DL

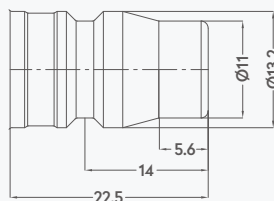

S = Surface hardened steel, galvanized

Compatible with

TST	013
Nitto	20, 30, 40
Cejn	315
Rectus	13



tst®

SC Series DL

DN8
3/8"



SWING COUPLING SCHWENKUPPLUNG

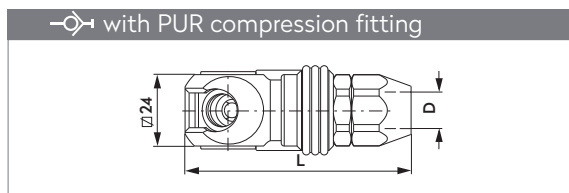
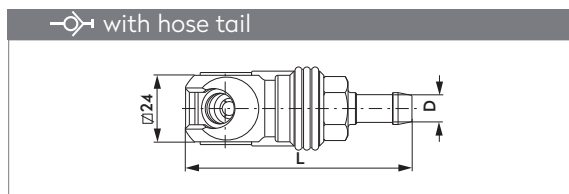
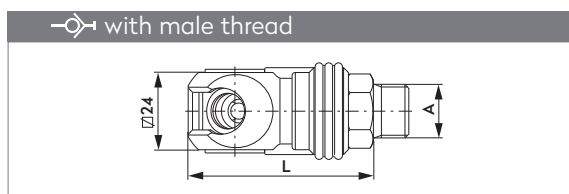
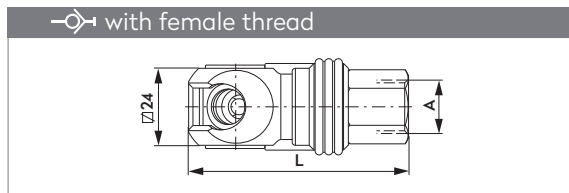

A	Part No.	L	L (swivel)
G1/4	205 00 060	68.0	74.5
G3/8	205 00 061	68.0	74.5
G1/2	205 00 062	69.0	75.5
NPT1/4	205 00 072	68.0	74.5
NPT3/8	205 00 073	68.0	74.5
NPT1/2	205 00 074	73.0	79.5

A	Part No.	L	L (swivel)
G1/4	205 00 063	57.0	63.5
G3/8	205 00 064	57.0	63.5
G1/2	205 00 065	58.0	64.5
NPT1/4	205 00 427	55.7	62.2
NPT3/8	205 00 075	55.7	62.2
NPT1/2	205 00 076	58.0	64.5

D	Part No.	L	L (swivel)
8 mm 5/16"	205 00 077	81.0	87.5
10 mm 3/8"	205 00 078	81.0	87.5
13 mm 1/2"	205 00 079	81.0	87.5

D	Part No.	L
8 X 12	205 00 081	75.3
11 X 16	205 00 082	80.3

PLUG STECKNIPPEL

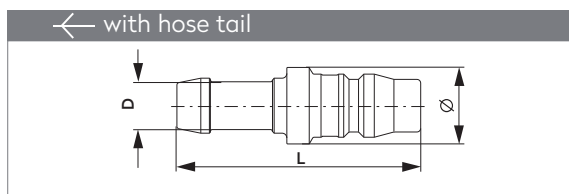
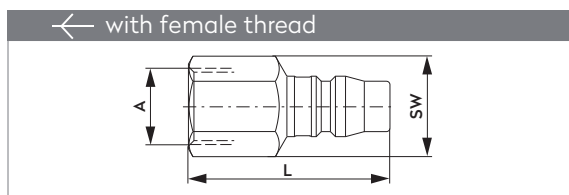
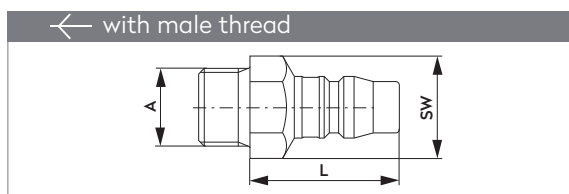

A	Part No.	L	SW
G1/4	255 00 032	32.0	14
G3/8	255 00 033	32.0	19
G1/2	255 00 034	32.0	24
NPT1/4	255 00 058	28.7	14
NPT3/8	255 00 059	28.7	19
NPT1/2	255 00 060	33.0	24

A	Part No.	L	SW
G1/4	255 00 035	43.0	17
G3/8	255 00 036	44.0	19
G1/2	255 00 037	48.5	27
NPT1/4	255 00 061	43.0	17
NPT3/8	255 00 062	44.0	19
NPT1/2	255 00 063	49.0	27

D	Part No.	L	\varnothing
8 mm 5/16"	255 00 038	51.0	14
10 mm 3/8"	255 00 039	51.0	14
13 mm 1/2"	255 00 040	51.0	16



SC Series E

DN8

3/8"

NEW!



ISO 4414	EN 983
US: MIL-C-4109	
ISO 6150-B-15	
AFNOR: B-15 NF E 49-053	



EN

Features

- Full flow, negligible loss of pressure
- Simple operation, no force required
- Compact design

DE

Auf einen Blick

- Voller Durchgang, geringer Druckverlust
- Einfache Bedienung ohne Kraftaufwand
- Kompakte Bauform

FR

En bref

- Passage intégral, faible perte de pression
- Maniement simple et sans efforts
- Construction compacte

NL

In een oogopslag

- Volledige doorlaat, weinig drukverlies
- Eenvoudige bediening zonder krachtsinspanning
- Compact ontwerp

Operating Pressure	Betriebsdruck	Pression de service	Werkdruk
<ul style="list-style-type: none"> • Up to 25 bar, Vacuum till 100 mbar • connection/disconnection to max. 15 bar 	<ul style="list-style-type: none"> • Bis 25 bar, techn. Vakuum bis 100 mbar • ein-/auskuppeln bis max. 15 bar 	<ul style="list-style-type: none"> • Jusqu'à 25 bar, Vide technique jusqu'à 100 mbar • accouplement/désaccouplement jusqu'à 15 bar max 	<ul style="list-style-type: none"> • tot 25 bar, 100 mbar Vacuum • aan- en afkoppelen tot max. 15 bar

<p>-20° to + 100°C (NBR) -4° to + 212°F</p>	<p>5001079</p>	<p>295 00 515</p>
---	----------------	-------------------

Materials, Seals	Material Code	Optional
	<p>A = Steel, nickel plated (for thread) aluminum (for hose tail)</p> <p>B = Steel, tenifer treated</p> <p>C = Stainless steel</p> <p>E = Nitrile elastomer (NBR)</p> <p>I = Surface hardened steel, nickel plated</p> <p>S = Surface hardened steel, galvanized</p> <p>Z = Zinc diecast, nickel plated, orange rubber coating</p>	<div style="display: flex; justify-content: space-between;"> <div> </div> <div> <p>295 00 340</p> </div> </div> <div style="display: flex; justify-content: space-between; margin-top: 10px;"> <div> </div> <div> <p>295 00 481</p> </div> </div>

Options	Plug Profile E	Compatible with														
<div style="display: flex; justify-content: space-around;"> <div style="border: 1px solid red; padding: 5px; background-color: red; color: white;">FPM</div> <div style="border: 1px solid red; padding: 5px; background-color: red; color: white;">EPDM</div> <div style="border: 1px solid red; padding: 5px; background-color: red; color: white;">Swivel NEW</div> <div style="border: 1px solid red; padding: 5px; background-color: red; color: white;">AISI303 NEW <small>Stainless Steel</small></div> </div>	<p>S = Surface hardened steel, galvanized</p>	<table border="0"> <tr><td>TST</td><td>030</td></tr> <tr><td>Industrial Interchange</td><td>3/8"</td></tr> <tr><td>AMFLO</td><td>C26</td></tr> <tr><td>Cejn</td><td>430</td></tr> <tr><td>Hansen</td><td>440</td></tr> <tr><td>Foster</td><td>4404</td></tr> <tr><td>Parker</td><td>25F</td></tr> </table>	TST	030	Industrial Interchange	3/8"	AMFLO	C26	Cejn	430	Hansen	440	Foster	4404	Parker	25F
TST	030															
Industrial Interchange	3/8"															
AMFLO	C26															
Cejn	430															
Hansen	440															
Foster	4404															
Parker	25F															



tst®

SC Series E

DN8
3/8"



SWING COUPLING SCHWENKKUPPLUNG

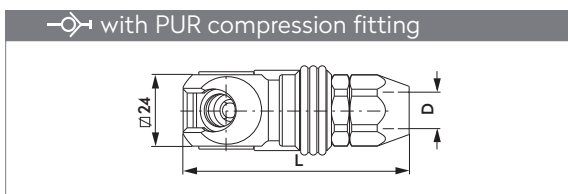
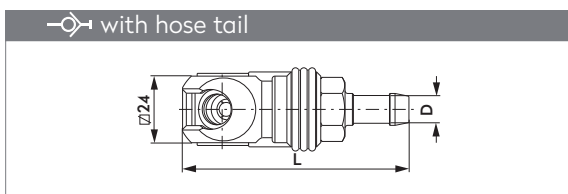
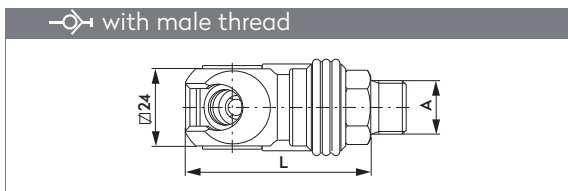
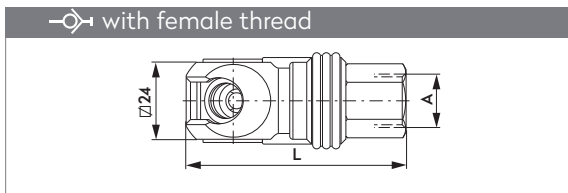

A	Part No.	L	L (swivel)
G1/4	205 00 023	68.5	74.5
G3/8	205 00 024	68.5	74.5
G1/2	205 00 025	69.5	75.5
NPT1/4	205 00 052	68.5	74.5
NPT3/8	205 00 026	68.5	74.5
NPT1/2	205 00 027	73.5	79.5

A	Part No.	L	L (swivel)
G1/4	205 00 028	57.5	63.5
G3/8	205 00 029	57.5	63.5
G1/2	205 00 045	58.5	64.5
NPT1/4	205 00 214	56.2	62.2
NPT3/8	205 00 030	56.2	62.2
NPT1/2	205 00 031	58.5	64.5

D	Part No.	L	L (swivel)
8 mm 5/16"	205 00 083	81.5	87.5
10 mm 3/8"	205 00 084	81.5	87.5
13 mm 1/2"	205 00 085	81.5	87.5

D	Part No.	L
8 X 12	205 00 087	75.8
11 X 16	205 00 088	80.8

PLUG STECKNIPPEL

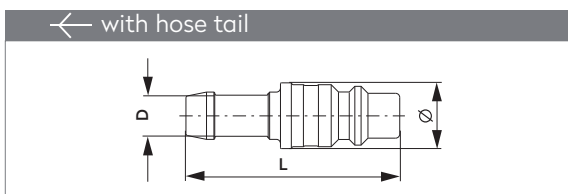
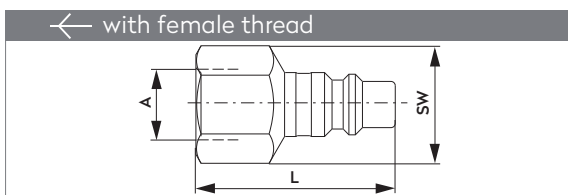
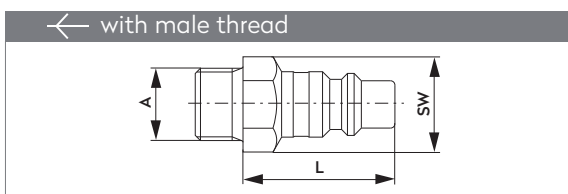

A	Part No.	L	SW
G1/4	255 00 041	35.0	17
G3/8	255 00 042	35.0	19
NPT1/4	255 00 236	31.7	17
NPT3/8	255 00 044	31.7	19
NPT1/2	255 00 045	36.0	24

A	Part No.	L	SW
G1/4	255 00 046	46.0	17
G3/8	255 00 047	47.0	24
NPT1/4	255 00 237	46.0	17
NPT3/8	255 00 049	47.0	24
NPT1/2	255 00 050	52.0	27

D	Part No.	L	\varnothing
8 mm 5/16"	255 00 051	52.0	16
10 mm 3/8"	255 00 052	52.0	16
13 mm 1/2"	255 00 053	52.0	16



tst®

SC Series E1

DN8
3/8"



SWING COUPLING SCHWENKKUPPLUNG

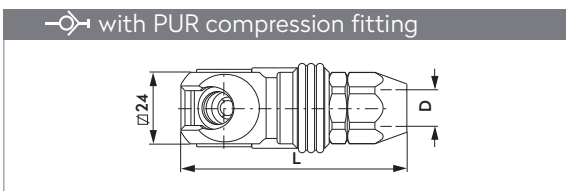
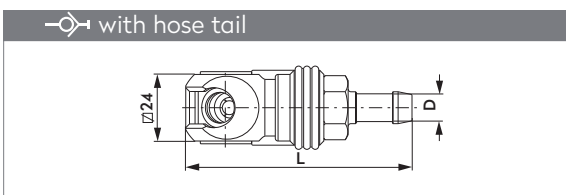
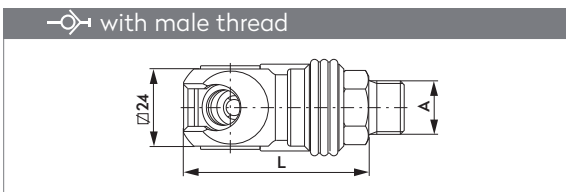
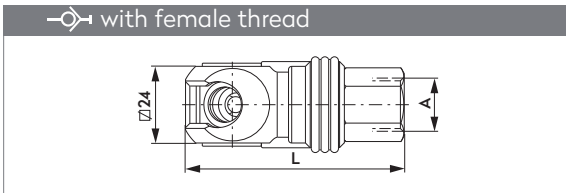

A	Part No.	L	L (swivel)
G1/4	205 00 115	69.5	74.5
G3/8	205 00 116	69.5	74.5
G1/2	205 00 117	70.5	75.5
NPT1/4	205 00 118	69.5	74.5
NPT3/8	205 00 119	69.5	74.5
NPT1/2	205 00 120	74.5	79.5

A	Part No.	L	L (swivel)
G1/4	205 00 121	58.5	63.5
G3/8	205 00 122	58.5	63.5
G1/2	205 00 123	59.5	64.5
NPT1/4	205 00 383	57.2	62.2
NPT3/8	205 00 124	57.2	62.2
NPT1/2	205 00 125	59.5	64.5

A	Part No.	L	L (swivel)
8 mm 5/16"	205 00 126	82.5	87.5
10 mm 3/8"	205 00 127	82.5	87.5
13 mm 1/2"	205 00 128	82.5	87.5

A	Part No.	L
8 X 12	205 00 130	76.8
11 X 16	205 00 131	81.8

PLUG STECKNIPPEL

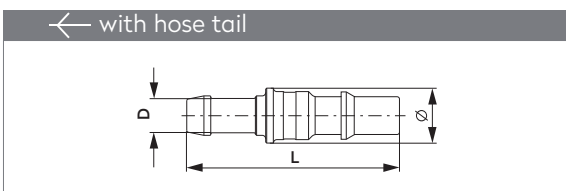
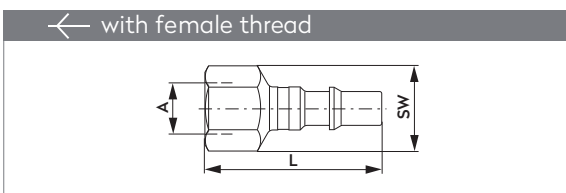
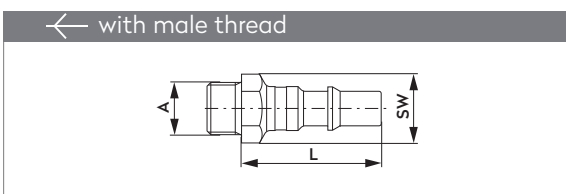

A	Part No.	L	SW
G1/4	255 00 101	44.5	17
G3/8	255 00 102	44.5	19
NPT1/4	255 00 090	44.7	17
NPT3/8	255 00 089	44.7	19

A	Part No.	L	SW
G1/4	255 00 103	55.5	17
G3/8	255 00 105	57.5	24
NPT1/4	255 00 104	56.5	17
NPT3/8	255 00 106	57.5	24

D	Part No.	L	\varnothing
8 mm 5/16"	255 00 107	62.0	14
10 mm 3/8"	255 00 108	62.0	14
13 mm 1/2"	255 00 109	62.0	16
16 mm 5/8"	255 00 110	62.0	22

NEW!



EN 139

EN 270



EN

Features

- Coupling for breathing air apparatus
- BBG approved
- Full flow, negligible loss of pressure
- Simple operation, no force required

DE

Auf einen Blick

- Schlauchkupplung für Atemluftgeräte
- BBG geprüft
- Voller Durchgang, geringer Druckverlust
- Einfache Bedienung ohne Kraftaufwand

FR

En bref

- Coupleur pour des équipements d'air respirable
- Vérifié par le BBG
- Passage intégral, faible perte de pression
- Maniement simple et sans efforts

NL

In een oogopslag

- Slangkoppeling voor ademluchtapparatuur
- Goedgekeurd door het BBG
- Volledige doorlaat, weinig drukverlies
- Eenvoudige bediening, zonder krachtsinspanning

Operating Pressure	Betriebsdruck	Pression de service	Werkdruk
<ul style="list-style-type: none"> • Up to 25 bar, Vacuum till 100 mbar • connection/disconnection to max. 15 bar 	<ul style="list-style-type: none"> • Bis 25 bar, techn. Vakuum bis 100 mbar • ein-/auskuppeln bis max. 15 bar 	<ul style="list-style-type: none"> • Jusqu'à 25 bar, Vide technique jusqu'à 100 mbar • accouplement/désaccouplement jusqu'à 15 bar max 	<ul style="list-style-type: none"> • tot 25 bar, 100 mbar Vacuum • aan- en afkoppelen tot max. 15 bar

<p>-20° to +100°C (NBR) -4° to +212°F</p>	<p>5005661</p>	<p>295 00 003</p>
---	----------------	-------------------

Materials, Seals	Material Code	Optional
	<p>A = Brass, Chrome plated (for thread) Aluminum (for hose tail)</p> <p>B = Brass, Chrome plated</p> <p>C = Stainless steel, 1.4310</p> <p>E = Nitrile elastomer (NBR)</p> <p>I = Brass, chrome plated</p> <p>S = Brass, chrome plated</p> <p>T = Zinc diecast, nickel plated</p>	<p>295 00 385</p> <p>295 00 480</p>

Options	Plug Profile M	Compatible with
<p>FPM</p> <p>EPDM</p> <p>Swivel NEW</p> <p>AISI303 NEW Stainless Steel</p>	<p>S = Brass, chrome plated</p>	<p>TST 095, 096</p> <p>Cejn 344, *342</p> <p>Rectus 95 KS, *96 KS</p> <p>* Coupling only</p>



SWING COUPLING SCHWENKUPPLUNG

with female thread

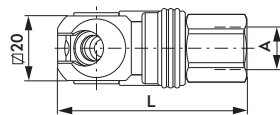

with male thread

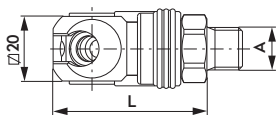

with hose tail

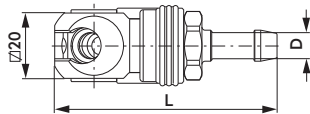

A	Part No.	L	L (swivel)
G1/4	205 00 738	56.1	74.5
G3/8	205 00 691	57.6	74.5
NPT1/4	205 00 696	56.1	75.5
NPT3/8	205 00 697	58.6	74.5

A	Part No.	L	L (swivel)
G1/4	205 00 739	47.6	63.5
G3/8	205 00 717	47.6	63.5
NPT1/4	205 00 740	48.8	64.5
NPT3/8	205 00 699	48.8	62.2

D	Part No.	L	L (swivel)
6 mm 1/4"	205 00 741	68.1	87.5
8 mm 5/16"	205 00 671	68.1	87.5
10 mm 3/8"	205 00 698	68.1	87.5
13 mm 1/2"	205 00 742	68.1	87.5

PLUG STECKNIPPEL

with male thread

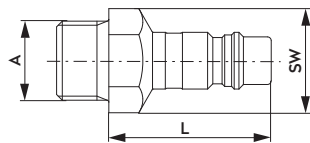

with female thread

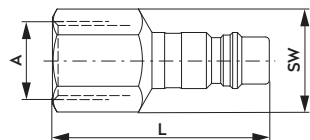

with hose tail

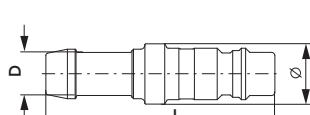

A	Part No.	L	SW
G1/4	255 00 420	34.2	14
G3/8	255 00 421	34.2	19
G1/2	255 00 422	35.2	24
NPT1/4	255 00 433	31.9	14
NPT3/8	255 00 434	31.9	19

A	Part No.	L	SW
G1/4	255 00 423	45.2	17
G3/8	255 00 424	46.2	19
G1/2	255 00 425	51.2	27
NPT1/4	255 00 435	45.2	17
NPT3/8	255 00 430	46.2	19

D	Part No.	L	Ø
6 mm 1/4"	255 00 426	53.2	14
8 mm 5/16"	255 00 418	53.2	14
10 mm 3/8"	255 00 427	53.2	14
13 mm 1/2"	255 00 428	53.2	16

NEW!



ISO 4414

EN 983



EN

Features

- Full flow, negligible loss of pressure
- Simple operation, no force required
- Compact design

DE

Auf einen Blick

- Voller Durchgang, geringer Druckverlust
- Einfache Bedienung ohne Kraftaufwand
- Kompakte Bauform

FR

En bref

- Passage intégral, faible perte de pression
- Maniement simple et sans efforts
- Construction compacte

NL

In een oogopslag

- Volledige doorlaat, weinig drukverlies
- Eenvoudige bediening zonder krachtsinspanning
- Compact ontwerp

Operating Pressure	Betriebsdruck	Pression de service	Werkdruk
<ul style="list-style-type: none"> • Up to 25 bar, Vacuum till 100 mbar • connection/disconnection to max. 15 bar 	<ul style="list-style-type: none"> • Bis 25 bar, techn. Vakuum bis 100 mbar • ein-/auskuppeln bis max. 15 bar 	<ul style="list-style-type: none"> • Jusqu'à 25 bar, Vide technique jusqu'à 100 mbar • accouplement/désaccouplement jusqu'à 15 bar max 	<ul style="list-style-type: none"> • tot 25 bar, 100 mbar Vacuum • aan- en afkoppelen tot max. 15 bar

<p>-20° to +100°C (NBR) -4° to +212°F</p>	<p>OM200-01100</p>	<p>295 00 515</p>
---	--------------------	-------------------

Materials, Seals

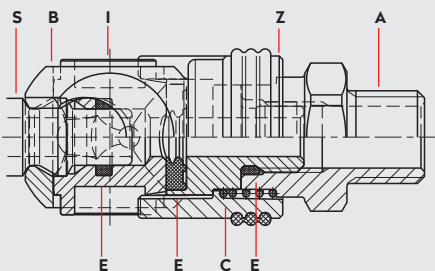

Material Code

- A = Steel, nickel plated / aluminum
- B = Steel, tenifer treated
- C = Stainless steel
- E = Nitrile elastomer (NBR)
- I = Surface hardened steel, nickel plated
- S = Surface hardened steel, galvanized
- Z = Zinc diecast, nickel plated, orange rubber coating

Optional

	295 00 340
	295 00 481

Options



Plug Profile J

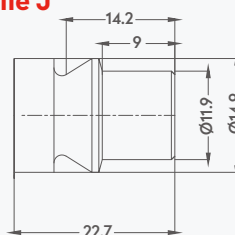

S = Surface hardened steel, galvanized

Compatible with

TST	040
ARO	310
Orion	44530
Rectus	40



tst®

SC Series J

DN8
3/8"



SWING COUPLING SCHWENKKUPPLUNG

with female thread

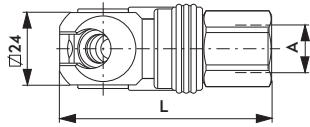

A	Part No.	L	L (swivel)
G3/8	205 00 871	68.5	78.0
G1/2	205 00 872	69.5	79.0

with male thread

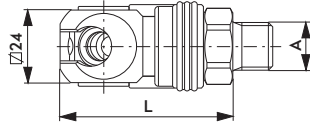

A	Part No.	L	L (swivel)
G1/2	205 00 873	58.5	68.0

with hose tail

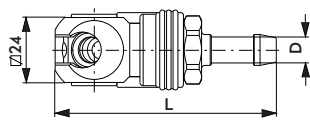

D	Part No.	L	L (swivel)
10 mm 3/8"	205 00 874	81.5	91.0
13 mm 1/2"	205 00 875	81.5	91.0

PLUG STECKNIPPEL

with male thread

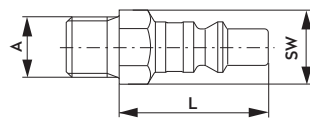

A	Part No.	L	SW
G1/4	255 00 455	37.0	16
G3/8	255 00 456	37.0	17
G1/2	255 00 457	40.0	22

with female thread

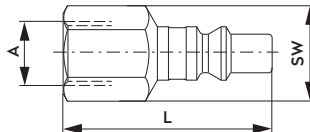

A	Part No.	L	SW
G1/4	255 00 452	37.0	16
G3/8	255 00 453	39.0	21
G1/2	255 00 454	42.0	24

with hose tail

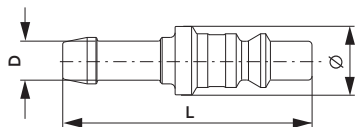

D	Part No.	L	\varnothing
8 mm 5/16"	255 00 458	56.0	15.7
10 mm 3/8"	255 00 459	56.0	15.7
13 mm 1/2"	255 00 460	56.0	15.7
16 mm 5/8"	255 00 461	56.0	20

ISO 4414 EN 983
 ISO 6150-C-17
 AFNOR: C-17 NF E 49-053



EN

Features

- Full flow, negligible loss of pressure
- Simple operation, no force required
- Compact design

DE

Auf einen Blick

- Voller Durchgang, geringer Druckverlust
- Einfache Bedienung ohne Kraftaufwand
- Kompakte Bauform

FR

En bref

- Passage intégral, faible perte de pression
- Maniement simple et sans efforts
- Construction compacte

NL

In een oogopslag

- Volledige doorlaat, weinig drukverlies
- Eenvoudige bediening, zonder krachtsinspanning
- Compact ontwerp

Operating Pressure	Betriebsdruck	Pression de service	Werkdruk
<ul style="list-style-type: none"> • Up to 25 bar, Vacuum till 100 mbar • connection/disconnection to max. 15 bar 	<ul style="list-style-type: none"> • Bis 25 bar, techn. Vakuum bis 100 mbar • ein-/auskuppeln bis max. 15 bar 	<ul style="list-style-type: none"> • Jusqu'à 25 bar, Vide technique jusqu'à 100 mbar • accouplement/désaccouplement jusqu'à 15 bar max 	<ul style="list-style-type: none"> • tot 25 bar, 100 mbar Vacuüm • aan- en afkoppelen tot max. 15 bar

<p>-20° to +100°C (NBR) -4° to +212°F</p>	<p>OM178-01560 05003602</p>	<p>295 00 094</p>
---	---------------------------------	-------------------

Materials, Seals	Material Code	Optional
	<p>A = Steel, nickel plated (for thread) aluminum (for hose tail) B = Steel, tenifer treated C = Stainless steel E = Nitrile elastomer (NBR) I = Surface hardened steel, nickel plated S = Steel, tenifer treated Z = Zinc diecast, nickel plated, orange rubber coating</p>	<div style="display: flex; align-items: center;"> <div> <p>295 00 531</p> </div> </div> <div style="display: flex; align-items: center; margin-top: 10px;"> <div> <p>295 00 482</p> </div> </div>

Options	Plug Profile G	Compatible with
<div style="display: flex; justify-content: space-around;"> <div style="background-color: red; color: white; padding: 5px;">FPM</div> <div style="background-color: red; color: white; padding: 5px;">EPDM</div> </div>	<p>S = Steel, tenifer treated</p>	<p>TST 107.11 TST SV - DN 11</p>



tst®

SC Series G

DN11 1/2"



SWING COUPLING SCHWENKKUPPLUNG

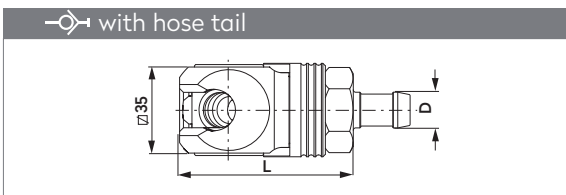
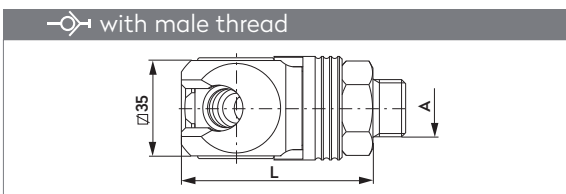
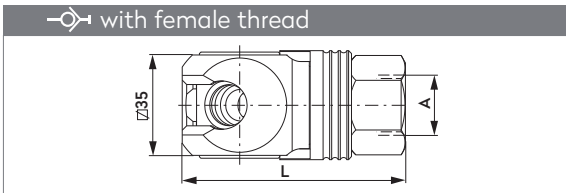

A	Part No.	L
G3/8	205 00 132	73.8
G1/2	205 00 133	77.8
G3/4	205 00 134	80.3
NPT3/8	205 00 138	78.8
NPT1/2	205 00 139	82.3
NPT3/4	205 00 140	83.3

A	Part No.	L
G3/8	205 00 135	70.3
G1/2	205 00 136	70.3
G3/4	205 00 137	70.3
NPT3/8	205 00 141	70.3
NPT1/2	205 00 142	70.3
NPT3/4	205 00 143	70.3

D	Part No.	L
13 mm 1/2"	205 00 737	93.3

PLUG STECKNIPPEL

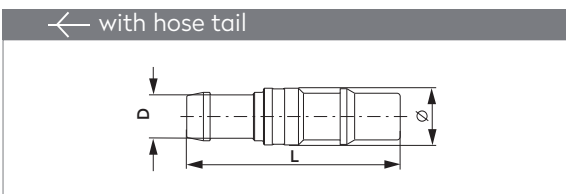
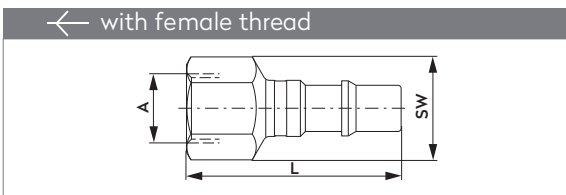
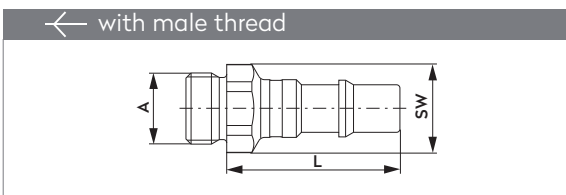

A	Part No.	L	SW
G3/8	255 00 131	51.0	24
G1/2	255 00 132	51.0	24
G3/4	255 00 133	51.0	27
NPT3/8	255 00 137	51.0	24
NPT1/2	255 00 138	51.0	24
NPT3/4	255 00 139	51.0	27

A	Part No.	L	SW
G3/8	255 00 128	65.0	24
G1/2	255 00 129	65.0	24
G3/4	255 00 130	69.0	32
NPT3/8	255 00 134	65.0	24
NPT1/2	255 00 135	67.0	27
NPT3/4	255 00 136	69.0	32

D	Part No.	L	\varnothing
10 mm 3/8"	255 00 140	64.0	17
13 mm 1/2"	255 00 141	64.0	17
16 mm 5/8"	255 00 142	66.0	22

ISO 4414	EN 983
US: MIL-C-4109	
ISO 6150-B-17	
AFNOR: C-17 NF E 49-053	



EN

Features

- Full flow, negligible loss of pressure
- Simple operation, no force required
- Compact design

DE

Auf einen Blick

- Voller Durchgang, geringer Druckverlust
- Einfache Bedienung ohne Kraftaufwand
- Kompakte Bauform

FR

En bref

- Passage intégral, faible perte de pression
- Maniement simple et sans efforts
- Construction compacte

NL

In een oogopslag

- Volledige doorlaat, weinig drukverlies
- Eenvoudige bediening, zonder krachtsinspanning
- Compact ontwerp

Operating Pressure	Betriebsdruck	Pression de service	Werkdruk
<ul style="list-style-type: none"> • Up to 25 bar, Vacuum till 100 mbar • connection/disconnection to max. 15 bar 	<ul style="list-style-type: none"> • Bis 25 bar, techn. Vakuum bis 100 mbar • ein-/auskuppeln bis max. 15 bar 	<ul style="list-style-type: none"> • Jusqu'à 25 bar, Vide technique jusqu'à 100 mbar • accouplement/désaccouplement jusqu'à 15 bar max 	<ul style="list-style-type: none"> • tot 25 bar, 100 mbar Vacuum • aan- en afkoppelen tot max. 15 bar

<p>-20° to +100°C (NBR) -4° to +212°F</p>	<p>OM178-01560 05003602</p>	<p>295 00 094</p>
---	---------------------------------	-------------------

Materials, Seals	Material Code	Optional
	<p>A = Steel, nickel plated (for thread) aluminum (for hose tail)</p> <p>B = Steel, tenifer treated</p> <p>C = Stainless steel</p> <p>E = Nitrile elastomer (NBR)</p> <p>I = Surface hardened steel, nickel plated</p> <p>S = Surface hardened steel, galvanized</p> <p>Z = Zinc diecast, nickel plated, orange rubber coating</p>	<div style="display: flex; align-items: center;"> <div style="margin-left: 10px;">295 00 531</div> </div> <div style="display: flex; align-items: center; margin-top: 10px;"> <div style="margin-left: 10px;">295 00 482</div> </div>

Options	Plug Profile H	Compatible with												
<div style="display: flex; justify-content: space-around;"> <div style="background-color: red; color: white; padding: 5px; border: 1px solid black;">FPM</div> <div style="background-color: red; color: white; padding: 5px; border: 1px solid black;">EPDM</div> </div>	<p>S = Surface hardened steel, galvanized</p>	<table border="0"> <tr> <td>TST</td> <td>037</td> </tr> <tr> <td>Industrial Interchange</td> <td>1/2"</td> </tr> <tr> <td>AMFLO</td> <td>C10</td> </tr> <tr> <td>Hansen</td> <td>520</td> </tr> <tr> <td>Foster</td> <td>5205</td> </tr> <tr> <td>Parker</td> <td>17</td> </tr> </table>	TST	037	Industrial Interchange	1/2"	AMFLO	C10	Hansen	520	Foster	5205	Parker	17
TST	037													
Industrial Interchange	1/2"													
AMFLO	C10													
Hansen	520													
Foster	5205													
Parker	17													



tst®

SC Series H

DN11
1/2"



SWING COUPLING SCHWENKKUPPLUNG

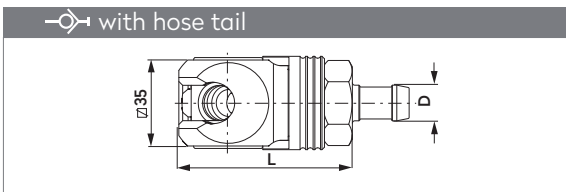
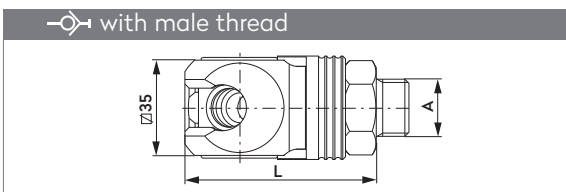
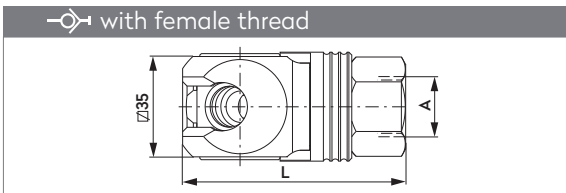

A	Part No.	L
G3/8	205 00 103	73.8
G1/2	205 00 104	77.8
G3/4	205 00 105	80.3
NPT3/8	205 00 109	78.8
NPT1/2	205 00 110	82.3
NPT3/4	205 00 111	83.3

A	Part No.	L
G3/8	205 00 106	70.3
G1/2	205 00 107	70.3
G3/4	205 00 108	70.3
NPT3/8	205 00 112	70.3
NPT1/2	205 00 113	70.3
NPT3/4	205 00 114	70.3

D	Part No.	L
13 mm 1/2"	205 00 712	93.3

PLUG STECKNIPPEL

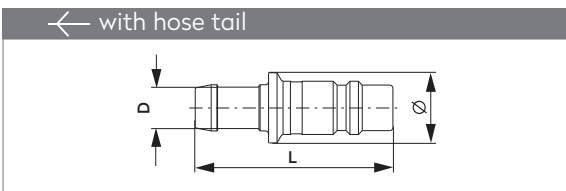
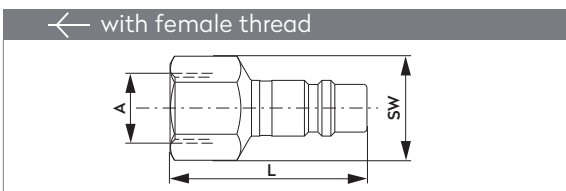
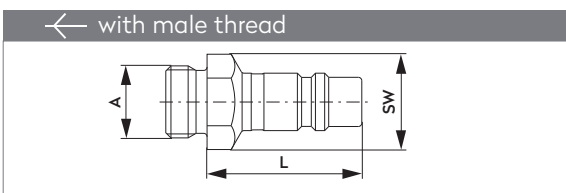

A	Part No.	L	SW
G3/8	255 00 074	45.0	19
G1/2	255 00 075	45.0	24
G3/4	255 00 290	45.0	27
NPT3/8	255 00 277	44.7	19
NPT1/2	255 00 278	44.0	24
NPT3/4	255 00 291	45.0	27

A	Part No.	L	SW
G3/8	255 00 076	59.0	19
G1/2	255 00 077	59.0	27
G3/4	255 00 078	63.0	32
NPT3/8	255 00 279	59.0	19
NPT1/2	255 00 280	61.0	27
NPT3/4	255 00 292	63.0	32

D	Part No.	L	\varnothing
10 mm 3/8"	255 00 079	64.0	22
13 mm 1/2"	255 00 080	62.0	22
16 mm 5/8"	255 00 081	64.0	22

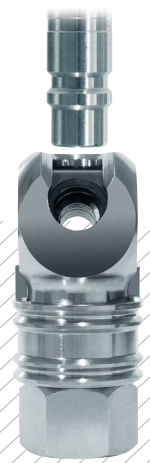

ISO 4414	EN 983
US: MIL-C-4109	
ISO 6150-B-17	
AFNOR: C-17 NF E 49-053	

<p>EN Features</p> <ul style="list-style-type: none"> Full flow, negligible loss of pressure Simple operation, no force required Easy grip release ring Corrosion and ozone proof 	<p>DE Auf einen Blick</p> <ul style="list-style-type: none"> Voller Durchgang, geringer Druckverlust Einfache Bedienung ohne Kraftaufwand Griffiger Auslösering Korrosions und ozonbeständig 	<p>FR En bref</p> <ul style="list-style-type: none"> Passage intégral, faible perte de pression Maniement simple et sans efforts Bague de déclenchement Résistant à la corrosion et à l'ozone 	<p>NL In een oogopslag</p> <ul style="list-style-type: none"> Volledige doorlaat, weinig drukverlies Eenvoudige bediening, zonder krachtsinspanning Ontkoppeling Bestand tegen corrosie en ozon
--	---	--	--

Operating Pressure	Betriebsdruck	Pression de service	Werkdruk
<ul style="list-style-type: none"> Up to 25 bar, Vacuum till 100 mbar connection/disconnection to max. 15 bar 	<ul style="list-style-type: none"> Bis 25 bar, techn. Vakuum bis 100 mbar ein-/auskuppeln bis max. 15 bar 	<ul style="list-style-type: none"> Jusqu'à 25 bar, Vide technique jusqu'à 100 mbar accouplement/désaccouplement jusqu'à 15 bar max 	<ul style="list-style-type: none"> tot 25 bar, 100 mbar Vacuum aan- en afkoppelen tot max. 15 bar

<p>-15° to + 200°C (FPM) +5° to + 392°F</p>	<p>5004875 5004725</p>	<p>295 00 095</p>
---	----------------------------	-------------------

<p>Materials, Seals</p>	<p>Material Code</p> <p>A = Brass, nickel plated B = Brass, nickel plated C = Stainless steel, 1.4310 E = FPM I = Aluminum S = Stainless steel, 1.4305 T = Brass, nickel plated</p>	<p>Optional</p> <p>295 00 531 295 00 482</p>
--------------------------------	--	---

<p>Options</p> <p>NBR EPDM</p>	<p>Plug Profile HB</p> <p>S = Stainless steel, 1.4305</p>	<p>Compatible with</p> <table border="0"> <tr><td>TST</td><td>037</td></tr> <tr><td>Industrial Interchange</td><td>1/2"</td></tr> <tr><td>AMFLO</td><td>C10</td></tr> <tr><td>Hansen</td><td>520</td></tr> <tr><td>Foster</td><td>5205</td></tr> <tr><td>Parker</td><td>17</td></tr> </table>	TST	037	Industrial Interchange	1/2"	AMFLO	C10	Hansen	520	Foster	5205	Parker	17
TST	037													
Industrial Interchange	1/2"													
AMFLO	C10													
Hansen	520													
Foster	5205													
Parker	17													

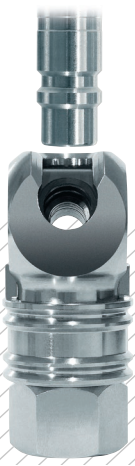

tst®

SC Series HB

DN11
1/2"



SWING COUPLING SCHWENKKUPPLUNG

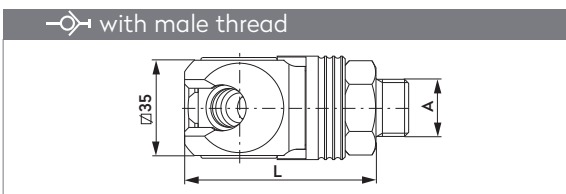
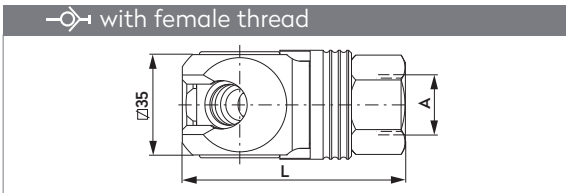

A	Part No.	L
G1/2	205 00 685	83.3
G3/4	205 00 684	90.3
NPT1/2	205 00 687	83.3
NPT3/4	205 00 686	90.3

A	Part No.	L
G1/2	205 00 743	80.3
G3/4	205 00 744	80.3
NPT1/2	205 00 745	83.3
NPT3/4	205 00 746	90.3

PLUG STECKNIPPEL

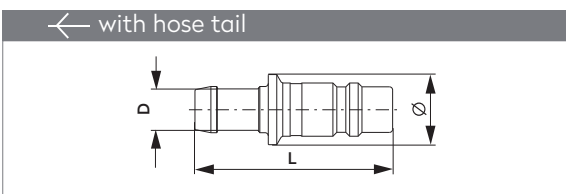
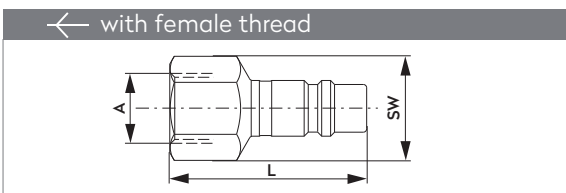
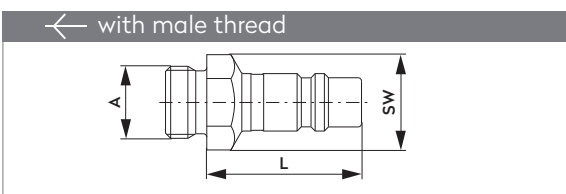

A	Part No.	L	SW
G3/8	355 00 250	45.0	19
G1/2	355 00 075	45.0	24
G3/4	355 00 327	45.0	27
NPT1/2	355 00 328	44.0	24
NPT3/4	355 00 253	45.0	27

A	Part No.	L	SW
G3/8	355 00 076	59.0	19
G1/2	355 00 077	59.0	27
G3/4	355 00 078	63.0	32
NPT1/2	355 00 255	61.0	27
NPT3/4	355 00 256	63.0	32

D	Part No.	L	\varnothing
10 mm 3/8"	355 00 079	64.0	22
13 mm 1/2"	355 00 080	62.0	22
16 mm 5/8"	355 00 081	64.0	22



ISO 4414 EN 983

ISO 6150-C-27

AFNOR: C-27 NF E 49-053

EN

Features

- Full flow, negligible loss of pressure
- Simple operation, no force required
- Compact design

DE

Auf einen Blick

- Voller Durchgang, geringer Druckverlust
- Einfache Bedienung ohne Kraftaufwand
- Kompakte Bauform

FR

En bref

- Passage intégral, faible perte de pression
- Maniement simple et sans efforts
- Construction compacte

NL

In een oogopslag

- Volledige doorlaat, weinig drukverlies
- Eenvoudige bediening, zonder krachtsinspanning
- Compact ontwerp



Operating Pressure

- Up to 25 bar, Vacuum till 100 mbar
- connection/disconnection to max. 15 bar



Betriebsdruck

- Bis 25 bar, techn. Vakuum bis 100 mbar
- ein-/auskuppeln bis max. 15 bar



Pression de service

- Jusqu'à 25 bar, Vide technique jusqu'à 100 mbar
- accouplement/désaccouplement jusqu'à 15 bar max



Werkdruk

- tot 25 bar, 100 mbar Vacuüm
- aan- en afkoppelen tot max. 15 bar



-20° to + 100°C (NBR)
-4° to + 212°F



29500123
29500127
05005461

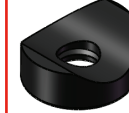

295 00 384

Materials, Seals

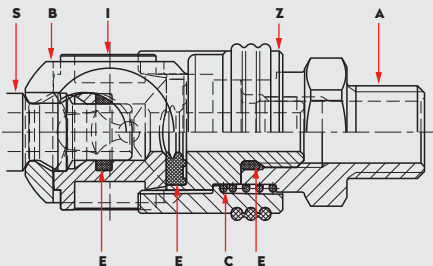

Material Code

A = Steel, nickel plated (for thread)
aluminum (for hose tail)
B = Steel, tenifer treated
C = Stainless steel
E = Nitrile elastomer (NBR)
I = Surface hardened steel, nickel plated
S = Steel, tenifer treated
Z = Zinc diecast, nickel plated,
orange rubber coating

Options

FPM

EPDM

Plug Profile I

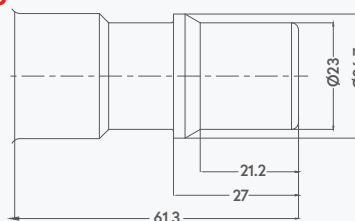

S = Steel, tenifer treated

Compatible with

TST 107.19
TST SV - DN 19



tst®

SC Series I

DN19
3/4"



SWING COUPLING SCHWENKKUPPLUNG

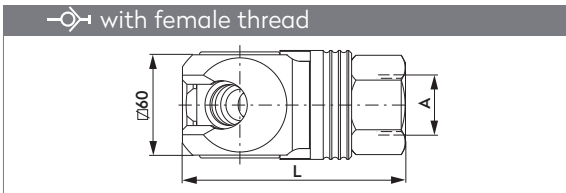

A	Part No.	L
G3/4	205 00 144	116.0
G1	205 00 145	116.0
NPT3/4	205 00 148	118.0
NPT1	205 00 149	121.0

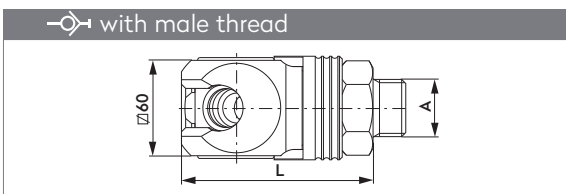

A	Part No.	L
G3/4	205 00 146	112.0
G1	205 00 147	112.0
NPT3/4	205 00 150	112.0
NPT1	205 00 151	112.0

PLUG STECKNIPPEL

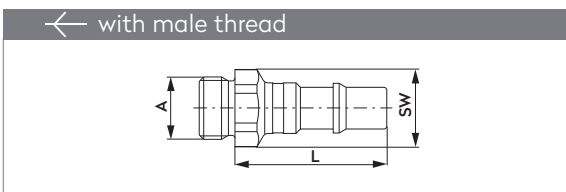

A	Part No.	L	SW
G3/4	255 00 082	81.0	36
G1	255 00 083	81.0	36

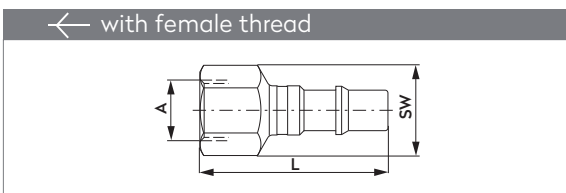

A	Part No.	L	SW
G3/4	255 00 084	89.0	36
G1	255 00 085	94.0	41

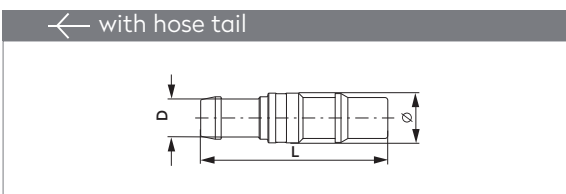

D	Part No.	L	Ø
LW19	255 00 086	105.0	32
LW25	255 00 087	111.0	32

TAMSAN BAĞLANTI ELEMANLARI A.Ş.

GEPOSB Gebze / Kocaeli TÜRKİYE

Factory Tel: +90 262 751 20 44

Fax: +90 262 751 30 44

info@tst-tamsan.com

EXPORT DEPARTMENT

Tel: +90 262 751 20 25

Fax: +90 262 751 20 50

sales@tst-tamsan.com

www.tst-tamsan.com

SWING COUPLING / SV SERIE / STAINLESS STEEL SERIE



SMART SOLUTIONS FOR INDUSTRIAL CONNECTIONS